



# Assembly Instructions

## **Aries 4 Seat Round Set** **(Product Codes: 69814096 & 69811096)**

**PLEASE RETAIN THIS DOCUMENT ALONG WITH YOUR  
PROOF OF PURCHASE FOR FUTURE REFERENCE**

Congratulations on your recent purchase of your beautiful Hartman furniture. We hope it brings you countless special moments with friends and family for many years to come.

Please follow these simple steps to build your furniture. We also have a very useful video available online to assist with the assembly, please visit [www.hartmanuk.com](http://www.hartmanuk.com)

### **TOP TIPS**

- Please read these instructions carefully before assembly, for further assistance please view our assembly video online for an easy step by step demonstration.
- Aluminium is a soft metal and over tightening may strip the thread or break the part, please loosely assembly your furniture before tightening to secure.
- Please **do not** use power tools, only use the tools provided in the bolt pack.
- Please allow 1 hour for assembly.
- This furniture can be assembled with **1** person; however, you may need someone to assist you when turning the furniture over into position.



# Assembly Instructions

## Aries 4 Seat Round Table (69814096)









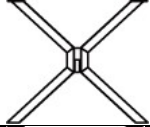

**PLEASE RETAIN THIS DOCUMENT ALONG WITH YOUR PROOF  
OF PURCHASE FOR FUTURE REFERENE**

Congratulations on your recent purchase of your beautiful Hartman furniture. We hope it brings you bountiful special moments with friends and family for many years to come. Please follow these simple steps to build your furniture. We also have a very useful video available online to assist with the assembly, please visit [www.hartmanuk.com](http://www.hartmanuk.com)

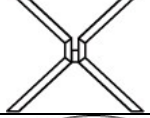
### TOP TIPS

- Please read these instructions carefully before assembly. For further assistance please view our assembly video online for an easy step by step demonstration.
- Aluminium is a soft metal and over tightening may strip the thread or break the part, please loosely assemble your furniture before tightening to secure.
- Please **do not** use power tools, please use the allen key provided in the bolt pack
- Please allow 1 hour for assembly
- This furniture can be assembled with **1** person; however, you may need someone to assist you when turning the furniture over into position.

## PARTS LIST

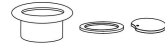
Component's				Fixings					
Parts List	Parts Picture	Description	Q'ty	Part no	Parts List	Parts Picture	Description	Q'ty	Part no
A		Table Top Frame	1	69814096A	E		M6* $\phi$ 16 Washer	4	1061162
B		Leg1	1	69814096B	F		M6x20 Bolt	4	1091162
C		Leg2	1	69814096C	G		Plastic Bolt Cap	4	106116
D		Glass	1	69814096D	H		M6 Allen Key	1	1010162
					I		Adjustable Feet	4	From HTM
					J		Sucker	12	1241165
					K		Parasol Bung, Reducer	1	2002184

## STEP 1 & 2: LEGS ASSEMBLY

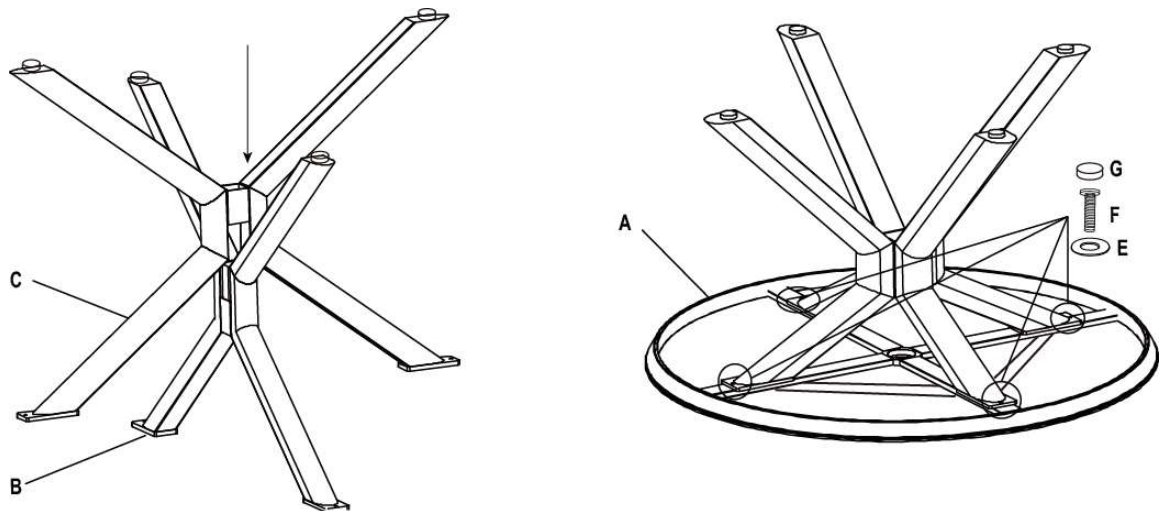

**STEP 1&2:** Inset leg2 (C) into leg1 (B)  
Then attach it on the bottom of table top frame (A), using bolt (F), washer (E).  
Tighten all the bolts and finish with the plastic bolt cap (G)

## STEP 3 : FINISHING

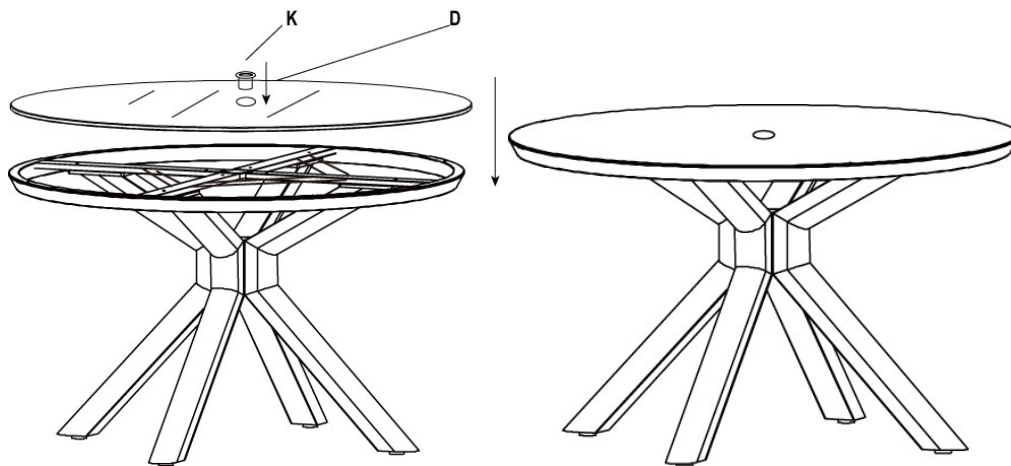

**STEP 3:** Turn the table over and place the glass (D) onto the table, then place the parasol bung, reducer ring & cap (K) into the hole.



# Assembly Instructions

## Aries Dining Chair (69811096)











**PLEASE RETAIN THIS DOCUMENT ALONG WITH YOUR PROOF  
OF PURCHASE FOR FUTURE REFERENE**

Congratulations on your recent purchase of your beautiful Hartman furniture. We hope it brings you bountiful special moments with friends and family for many years to come. Please follow these simple steps to build your furniture. We also have a very useful video available online to assist with the assembly, please visit [www.hartmanuk.com](http://www.hartmanuk.com)

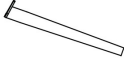
### TOP TIPS

- Please read these instructions carefully before assembly. For further assistance please view our assembly video online for an easy step by step demonstration.
- Aluminium is a soft metal and over tightening may strip the thread or break the part, please loosely assemble your furniture before tightening to secure.
- Please **do not** use power tools, please only use the tools provided in the bolt pack
- Please allow 1 hour for assembly.
- This furniture can be assembled with **1** person; however, you may need someone to assist you when turning the furniture over into position.

# PARTS LIST

Component's				Fixings					
Parts List	Parts Picture	Description	Q'ty	Part no	Parts List	Parts Picture	Description	Q'ty	Part no
A		Seat	1	69811096A	D		M6x20 Bolt	12	1091162
B		Rear leg	2	69811096B	E		Washer M6* φ 16	12	1061166
C		Front leg	2	69811096C	F		M6 Allen Key	1	1010162
I		Seat Cushion	1	69811096D	G		M6 Plastic Bolt Cap	12	1061116
J		Back Cushion	1	69811096E	H		Adjustable Footpad	4	1061176

## STEP 1 & 2: LEGS ASSEMBLY

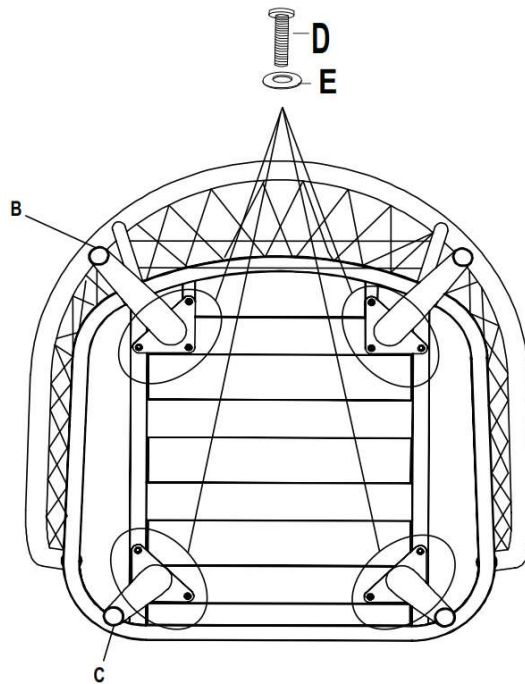

**STEP 1:** Attach front legs (C) to the seat (A), using an bolt M6x20 (D), washer (W)

**STEP 2:** Repeat step1 with rear leg (B)

## STEP 3 : TIGHTEN AND FINISHING



**STEP 3:** Tighten all the bolts on the chair and finish with the plastic bolt cap (G). Turn the chair over and place the seat cushion (I) and the back cushion (J) onto the chair