



Assembly Instructions

Aries Companion Set (69813096)









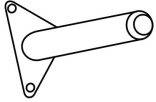

**PLEASE RETAIN THIS DOCUMENT ALONG WITH YOUR PROOF
OF PURCHASE FOR FUTURE REFERENCE**

Congratulations on your recent purchase of your beautiful Hartman furniture. We hope it brings you bountiful special moments with friends and family for many years to come. Please follow these simple steps to build your furniture. We also have a very useful video available online to assist with the assembly, please visit www.hartmanuk.com

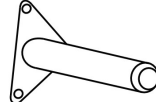
TOP TIPS

- Please read these instructions carefully before assembly. For further assistance please view our assembly video online for an easy step by step demonstration.
- Aluminium is a soft metal and over tightening may strip the thread or break the part, please loosely assemble your furniture before tightening to secure.
- Please **do not** use power tools, please use only use tools provided in the bolt pack.
- Please allow 1 hour for assembly.
- This furniture can be assembled by **2** people; however, you may need someone to assist you when turning the furniture over into position.

PARTS LIST - LOUNGE CHAIR X 2





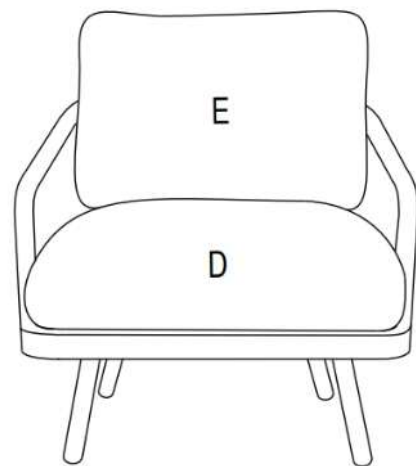
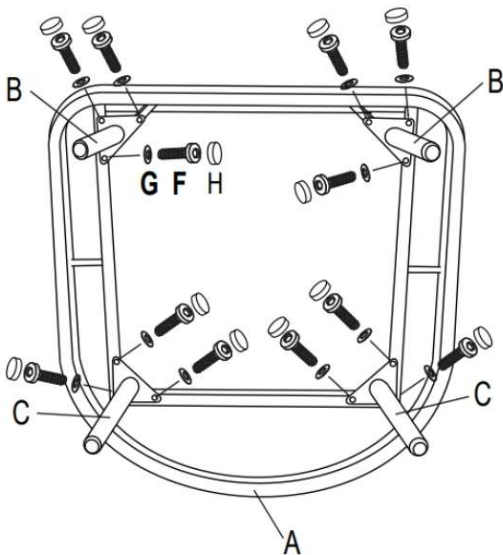

Components					Fixings				
Parts List	Parts Picture	Description	Qty	Part No.	Parts List	Parts Picture	Description	Qty	Part No.
A		Chair Frame	2	69813096A	F		M6x20 Bolt	12	1091162
B		Leg 1	2	69813096A	G		M6 Washer	12	1241163
C		Leg 2	2	69813096A	H		Bolt Cap	12	1061167
D		Seat Cushion	2	69813096D	I		M6 Allen Key	1	1010162
E		Back Cushion	2	69813096E	J		Adjustable Foot (ϕ 38)	8	2PNS007

STEP 1: LOUNGE CHAIR ASSEMBLY

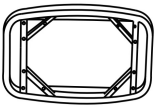

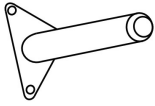
STEP 1: Attach leg 1 (B) and leg 2 (C) to the chair frame (A), using the bolt M6x20 (F) and washer (G). Tighten the bolts and cover the bolt cap (H)
Turn the chair over and place the seat cushion (D) and the back cushion (E) onto the chair.

PARTS LIST - STOOL X 2

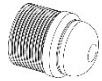



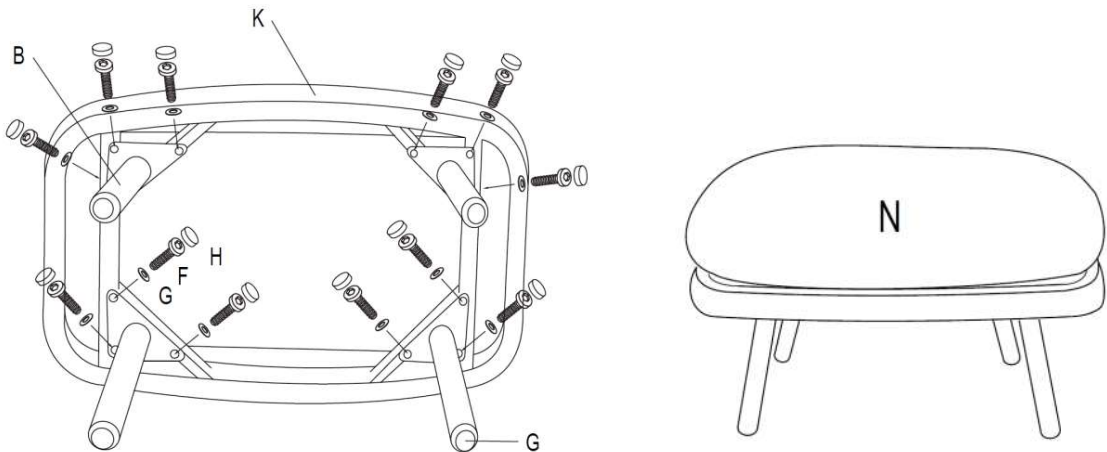



Components					Fixings				
Parts List	Parts Picture	Description	Qty	Part No.	Parts List	Parts Picture	Description	Qty	Part No.
A		Seat Frame	1	69813096K	F		M6x20 Bolt	12	1091162
B		Leg 1	4	69813096B	G		M6 Washer	12	1241163
C		Seat Cushion	1	69813096C	H		Bolt Cap	12	1061167
					I		M6 Allen Key	1	1010162
					J		Adjustable Feet (φ38)	4	2PNS007

STEP2: STOOLS ASSEMBLY

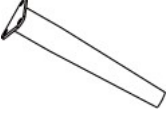

STEP 2: Attach leg1 (B) to the stool frame (K), using the bolt M6x20 (F) and washer (G). Tighten the bolts and cover the bolt cap (H)
Turn the stool over and place the seat cushion (N) onto the stool

PARTS LIST - SIDE TABLE

Components					Fixings				
Parts List	Parts Picture	Description	Qty	Part No.	Parts List	Parts Picture	Description	Qty	Part No.
M		Table Frame	1	69813096M	F		M6 Washer	12	1241163
N		Leg 3	1	69813096O	G		M6x20 Bolt	12	1091162
O		Glass	1	69813096P	H		Bolt Cap	12	1061167
					I		M6 Allen Key	12	1010162
					Q		Adjustable Feet (φ25)	4	1061188

STEP 3 & 4: SIDE TABLE ASSEMBLY

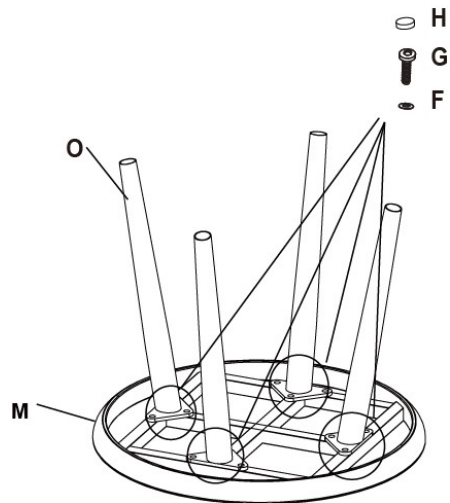

STEP 3: Attach leg3 (O) to the table frame (M), using the bolt M6X20 (F) and washer (G). Tighten the bolts and cover the bolt cap (H)

STEP 4: Turn the table over and place the glass (P) on the table.

