



Assembly Instructions

Orion 8 Seat Rectangular Dining Table

(Product Codes: 63111642)

**PLEASE RETAIN THIS DOCUMENT ALONG WITH YOUR
PROOF OF PURCHASE FOR FUTURE**





Congratulations on your recent purchase of your beautiful Hartman furniture. We hope it brings you **countless** special moments with friends and family for many years to come.

Please follow these simple steps to build your furniture. We also have a very useful video available online to assist with the assembly, please visit www.hartmanuk.com

TOP TIPS

- Please read these instructions carefully before assembly, for further assistance please view our assembly video online for an easy step by step demonstration.
- Aluminium is a soft metal and over tightening may strip the thread or break the part, please loosely assemble your furniture before tightening to secure.
- Please **do not** use power tools, please use the allen key provided in the bolt pack.
- Please allow 5 minutes for assembly.
- This furniture can be assembled with **1** person; however, you may need someone to assist you when turning the furniture over into position.

PARTS LIST

Component's					Fixings				
Parts List	Parts Picture	Description	QTY	Part no.	Parts list	Parts Picture	Description	QTY	Part no.
A		Table Top	1	63111642A	C		Bolt (M8*35)	8	
					D		Big Flat Washer (M8)	8	1001162
B		Table Leg	2	63111642B	E		Big Lock Washer (M8)	8	1002162

STEP 1 & 2: LEG ASSEMBLY

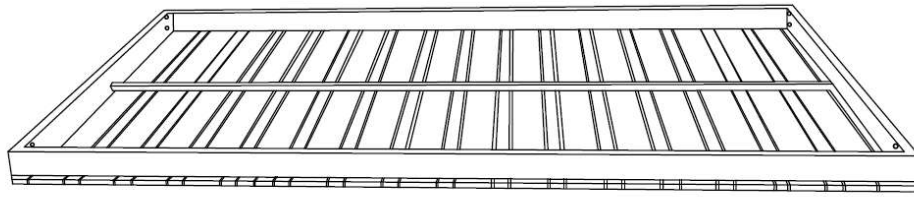

STEP 1: Turn the table top (A) upside down on a soft clean surface.

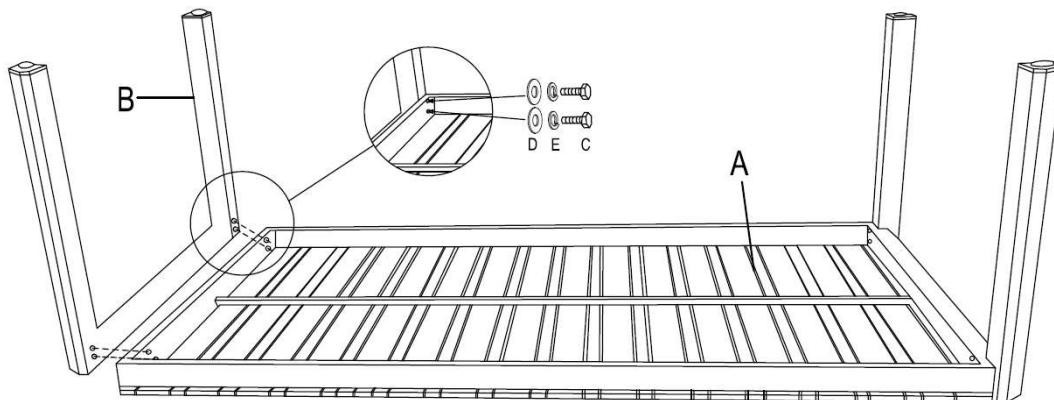

STEP 2: Attach the legs (B) to the table top (A) Secure these using Bolts (C) big flat washers (D), and big lock washers (E), tighten the bolts.

STEP 3: TURN TABLE OVER

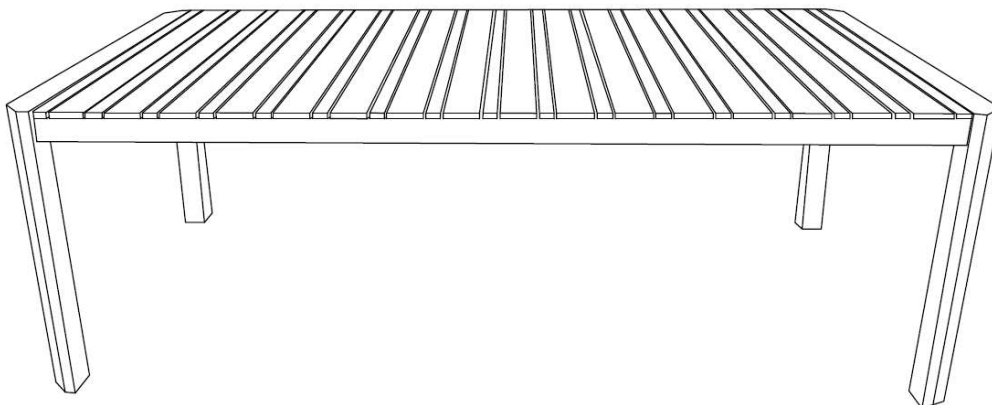

STEP 3: Turn the table on its legs, you can now use the table.