



# Assembly Instructions

## Rectangular Corner Seating Unit

(69710130)











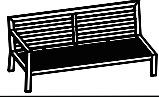

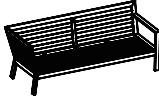
**PLEASE RETAIN THIS DOCUMENT ALONG WITH YOUR  
PROOF OF PURCHASE FOR FUTURE**

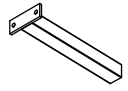
Congratulations on your recent purchase of your beautiful Hartman furniture. We hope it brings you bountiful special moments with friends and family for many years to come. Please follow these simple steps to build your furniture. We also have a very useful video available online to assist with the assembly, please visit [www.hartmanuk.com](http://www.hartmanuk.com)

### **TOP TIPS**

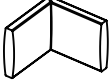
- Please read these instructions carefully before assembly, for further assistance please view our assembly video online for an easy step by step demonstration
- Aluminum is a soft metal and over tightening may strip the thread or break the part, please loosely assembly your furniture before tightening to secure.
- Please **do not** use power tools, please use the allen key provided in the bolt pack
- Please allow 5 minutes for assembly
- This furniture can be assembled with **2** persons; however, you may need someone to assist you when turning the furniture over into position.

# PARTS LIST

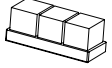
Components					Fixings				
Parts List	Parts Picture	Description	Qty	Part no	Parts List	Parts Picture	Description	Qty	Part no
A		Frame1 (left)	1	69710130A	J		Washer (M6Xφ16)	2	1061162
B		Frame2 (right)	1	69710130B	K		Bolt (M6X20)	2	1091162
C		Center leg	1	69710130C	L		Allen (M6)	1	1010162
D		Back cushion	4	5ROBC003PL	M		Plastic bolt cap (M6)	2	1061167
E		Corner back cushion	1	5ROCC002PL	N		Velcro	2	2200011
F		Seat cushion1 (right)	1	5ROSC004PL					
G		Seat cushion2 (left)	1	5ROSC005PL					
H		Adjustable footpad	1	2PIF014					
I		Plastic footpad	8	2PIF015					

## STEP 1: CENTER LEG ASSEMBLY

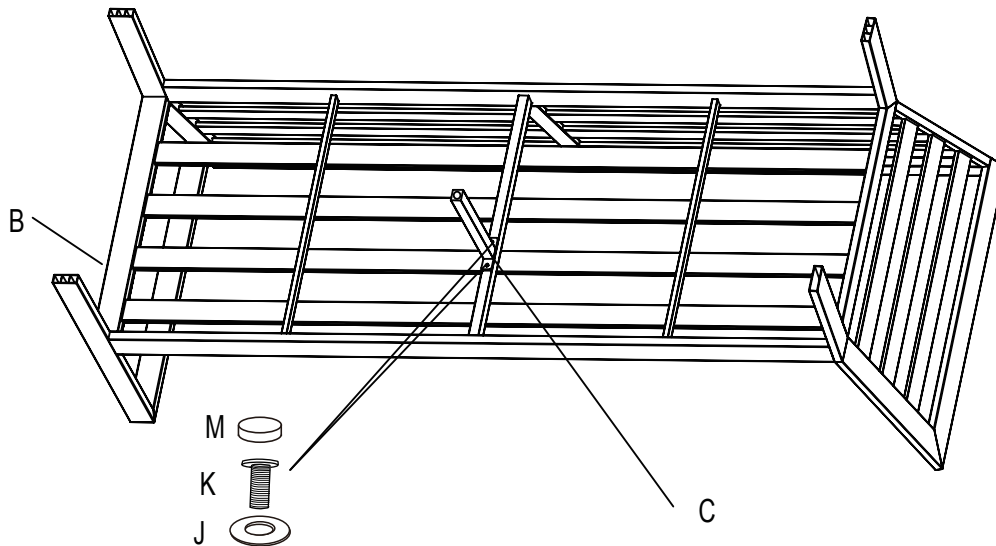

**STEP 1:** Attach Center leg (C) to the Frame 2 (B) using the M6x20 Bolt (K) and Washer (J), tighten and cover with the Plastic bolt cap (M). Turn the sofa over.

## STEP 2 & 3 : FINISHING

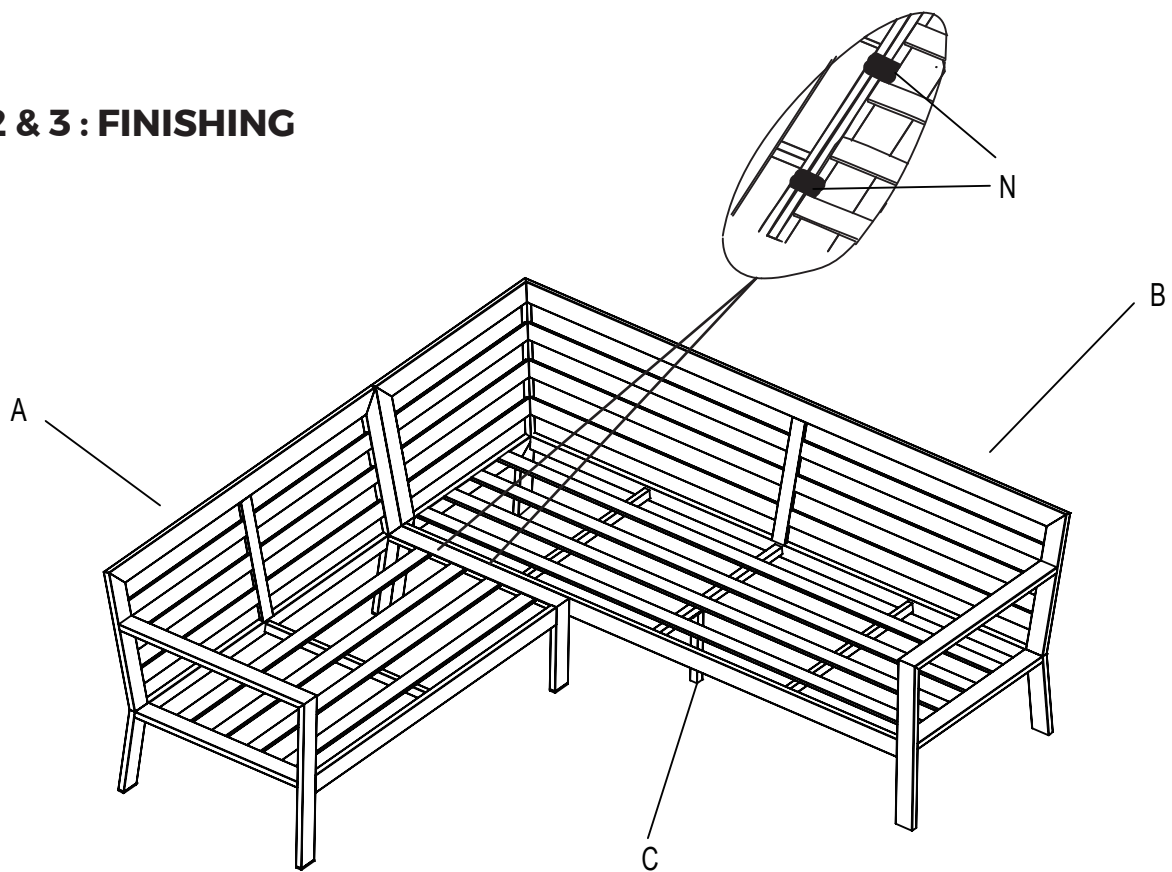

**STEP 2:** Fixed the rightside and leftside sofa using the Velcro (N).

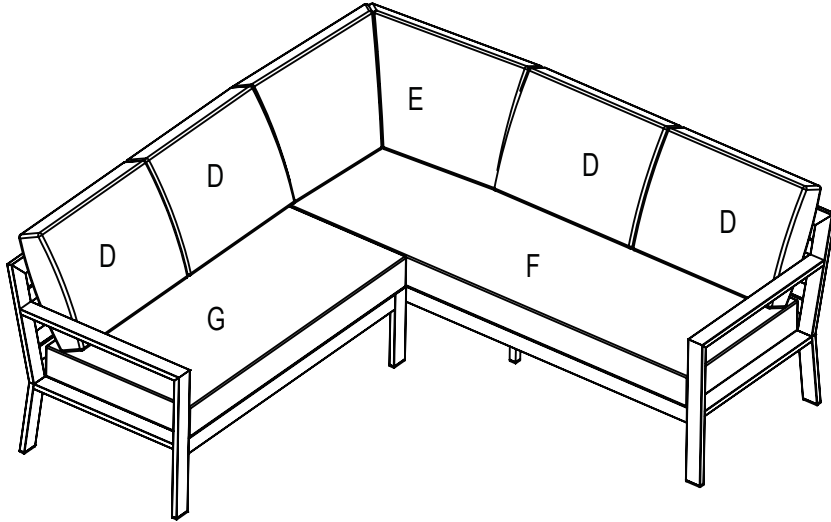

**STEP 3:** Place the Seat cushion (F), Seat cushion (G), Back cushion (D) and the Corner back cushion (E) onto the sofa