



Assembly Instructions

Sahara 3 Seat Lounge Set with Adjustable Table **(Product Codes: 64849099, 64859099, 64850099, 64870099)**

**PLEASE RETAIN THIS DOCUMENT ALONG WITH YOUR
PROOF OF PURCHASE FOR FUTURE REFERENCE**

Congratulations on your recent purchase of your beautiful Hartman furniture. We hope it brings you countless special moments with friends and family for many years to come.

Please follow these simple steps to build your furniture. We also have a very useful video available online to assist with the assembly, please visit www.hartmanuk.com

TOP TIPS

- Please read these instructions carefully before assembly, for further assistance please view our assembly video online for an easy step by step demonstration.
- Aluminium is a soft metal and over tightening may strip the thread or break the part, please loosely assemble your furniture before tightening to secure.
- Please **do not** use power tools, only use the tools provided in the bolt pack.
- Please allow 1 hour for assembly.
- This furniture can be assembled with **1** person; however, you may need someone to assist you when turning the furniture over into position.



Assembly Instructions

Sahara 3 Seat Sofa **(Product Code: 64849099)**













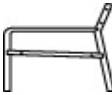

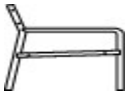
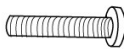
**PLEASE RETAIN THIS DOCUMENT ALONG WITH YOUR
PROOF OF PURCHASE FOR FUTURE REFERENCE**

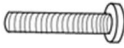
Congratulations on your recent purchase of your beautiful Hartman furniture. We hope it brings you bountiful special moments with friends and family for many years to come. Please follow these simple steps to build your furniture. We also have a very useful video available online to assist with the assembly, please visit www.hartmanuk.com

TOP TIPS

- Please read these instructions carefully before assembly. For further assistance please view our assembly video online for an easy step by step demonstration.
- Aluminium is a soft metal and over tightening may strip the thread or break the part, please loosely assemble your furniture before tightening to secure.
- Please **do not** use power tools, please only use the tools provided in the bolt pack.
- Please allow 1 hour for assembly
- This furniture can be assembled with **2** people; however, you may need someone to assist you when turning the furniture over into position.

PARTS LIST

Components					Fixings				
Parts List	Parts Picture	Description	Qty	Part No.	Parts List	Parts Picture	Description	Qty	Part No.
A		Seat Frame	1	64849099A	H		M6x16 Washer	12	1061162
B		Armrest 1	1	64849099B	I		M6x25 Flat Head Screw	4	1061182
C		Armrest 2	1	64849099C	J		M6x35 Bolt	8	1111162
D		Backrest	1	64849099D	K		M6x40 Bolt	4	1121162
E		Centre Leg	1	64849099E	L		M6 Bolt Cap	12	1061181
F		Seat Cushion	3	64849099F	M		M6 Allen Key	2	1010162
G		Back Cushion	3	64849099G	N		Frame Plug	2	1061185
					O		Adjustable Foot (φ36)	2	1061184
					P		Adjustable Foot (φ45)	4	1061180

STEP 1 & 2: ARMREST AND BACKREST ASSEMBLY

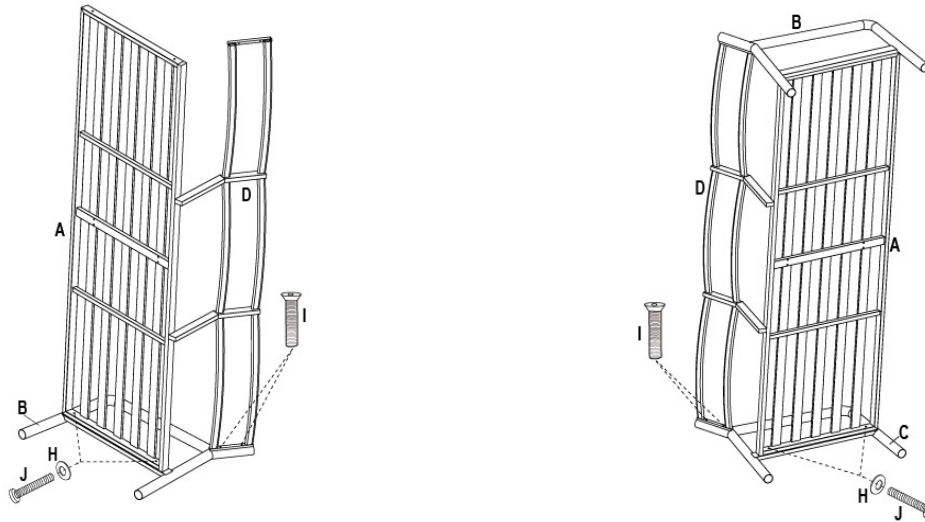

STEP 1: Attach armrest 1 (B) to the seat frame (A) using the bolt M6x35 (J) and Washer (H)
Attach backrest (D) to the seat frame (A) using the bolt M6x25 (I)

STEP 2: Repeat STEP1 to attach the armrest 2 (C) to the seat frame and backrest

STEP 3 & 4: LEG ASSEMBLY

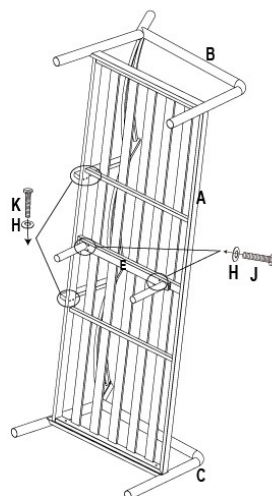

STEP 3: Attach backrest (D) to the seat frame (A) using the bolt M6x40 (K) and Washer (H)
STEP 4: Attach center leg (E) to the seat frame (A) using the bolt M6x35 (J) and Washer (H)

STEP 5: TIGHTENING AND FINISHING

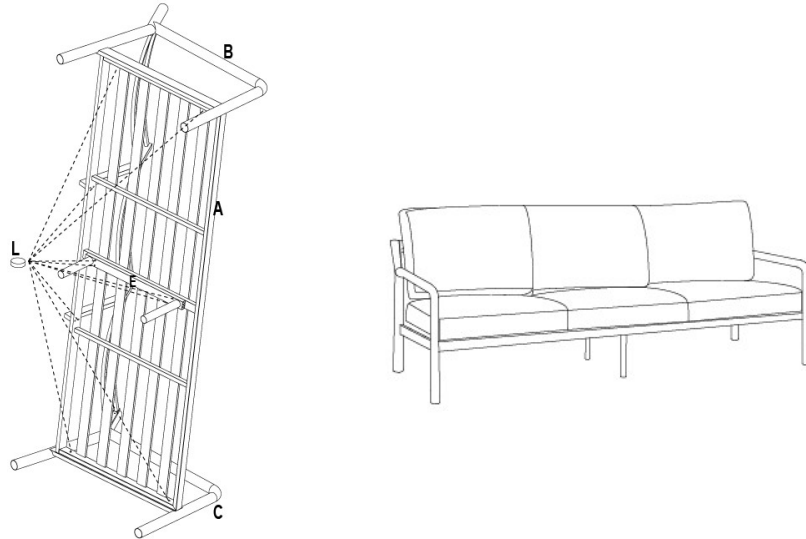

STEP 5: Tighten all the bolts on the sofa and cover with the bolt cap (L). Turn the sofa over and place the seat cushion (F) and the back cushion (G) onto the sofa



Assembly Instructions

Sahara Lounge Chair (Product Code: 64811099)











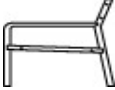

**PLEASE RETAIN THIS DOCUMENT ALONG WITH YOUR
PROOF OF PURCHASE FOR FUTURE REFERENCE**

Congratulations on your recent purchase of your beautiful Hartman furniture. We hope it brings you bountiful special moments with friends and family for many years to come. Please follow these simple steps to build your furniture. We also have a very useful video available online to assist with the assembly, please visit www.hartmanuk.com

TOP TIPS

- Please read these instructions carefully before assembly. For further assistance please view our assembly video online for an easy step by step demonstration.
- Aluminium is a soft metal and over tightening may strip the thread or break the part, please loosely assemble your furniture before tightening to secure.
- Please **do not** use power tools, please only use the tools provided in the bolt pack.
- Please allow 1 hour for assembly.
- This furniture can be assembled with **1** person; however, you may need someone to assist you when turning the furniture over into position.

PARTS LIST

Components					Fixings				
Parts List	Parts Picture	Description	Qty	Part No.	Parts List	Parts Picture	Description	Qty	Part No.
A		Seat Frame	1	64811099A	G		M6x16 Washer	4	1061162
B		Armrest 1	1	64811099B	H		M6x25 Flat Head Screw	4	1061182
C		Armrest 2	1	64811099C	I		M6x30 Bolt	4	1111162
D		Backrest	1	64811099D	J		M6 Bolt Cap	4	1061181
E		Seat Cushion	1	64811099E	K		M6 Allen Key	1	1010162
F		Back Cushion	1	64811099F	L		Adjustable Foot (φ45)	4	1061180

STEP 1 & 2: ARMREST AND BACKREST ASSEMBLY

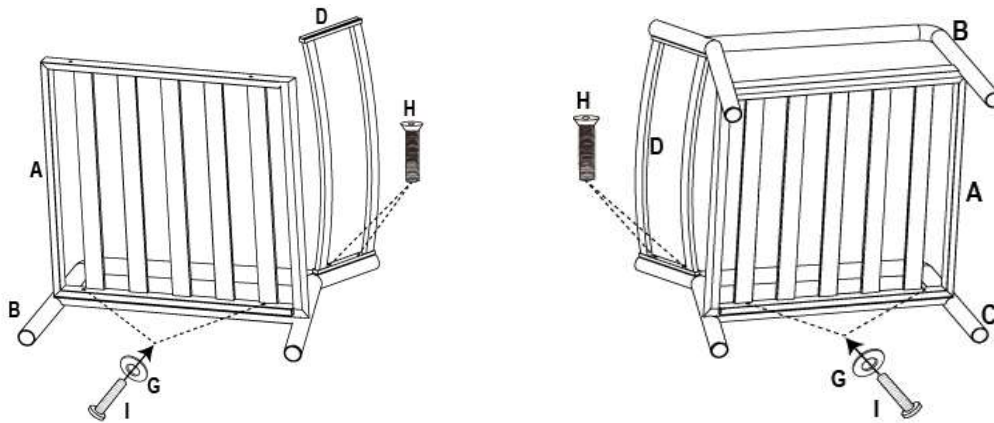

STEP 1: Attach armrest 1 (B) to the seat frame (A) using the bolt M6x35 (I) and Washer (G)
Attach backrest (D) to the seat frame (A) using the bolt M6x25 (H)

STEP 2: Repeat step 1 to attach the armrest 2 (C) to the seat frame and backrest

STEP 3: TIGHTENING AND FINISHING

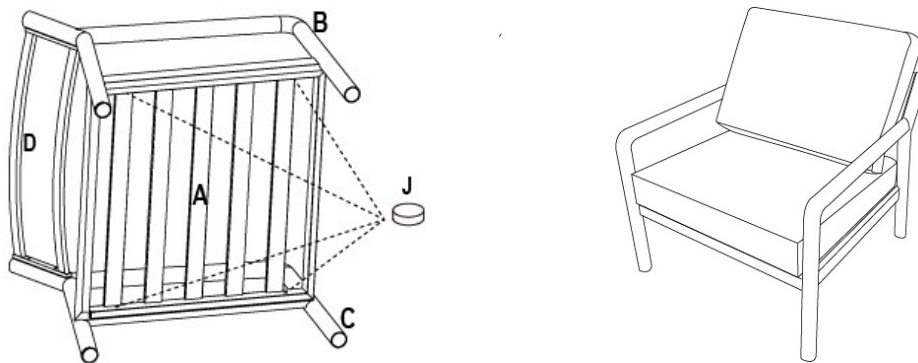

STEP 3: Tighten all the bolts on the chair and cover with the bolt cap (J). Turn the chair over and place the seat cushion (E) and the back cushion (F) onto the chair



Assembly Instructions

Sahara 170x90cm Rectangular Adjustable Table

(Product Codes: 64859099 & 64850099)













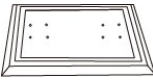

**PLEASE RETAIN THIS DOCUMENT ALONG WITH YOUR
PROOF OF PURCHASE FOR FUTURE REFERENCE**

Congratulations on your recent purchase of your beautiful Hartman furniture. We hope it brings you bountiful special moments with friends and family for many years to come. Please follow these simple steps to build your furniture. We also have a very useful video available online to assist with the assembly, please visit www.hartmanuk.com

TOP TIPS

- Please read these instructions carefully before assembly. For further assistance please view our assembly video online for an easy step by step demonstration.
- Aluminium is a soft metal and over tightening may strip the thread or break the part, please loosely assemble your furniture before tightening to secure.
- Please **do not** use power tools, please only use the tools provided in the bolt pack.
- Please allow 1 hour for assembly
- This furniture can be assembled with **2** people; however, you may need someone to assist you when turning the furniture over into position.

PARTS LIST

Components					Fixings				
Parts List	Parts Picture	Description	Qty	Part No.	Parts List	Parts Picture	Description	Qty	Part No.
A		Table Top	1	64859099A	D		M6x25 Washer	8	1017162
B		Leg Pillar	1	64850099B	E		M6x35 Washer	2	1111162
C		Base	1	64859099C	F		M8x55 Bolt	8	2002166
					G		M6* φ 12 Washer	10	1241162
					H		M8* φ 20 Washer	8	1061191
					I		M6 Bolt Cap	10	1061181
					J		M8 Bolt Cap	8	1061186
					K		M6 Lock Washer	10	1051163
					L		M8 Lock Washer	8	1063162
					M		M6 Allen Key	1	1010162
					N		M8 Allen Key	1	1051162
					O		Adjustable Foot	4	1061187

STEP 1 & 3: LEG PILLAR ASSEMBLY

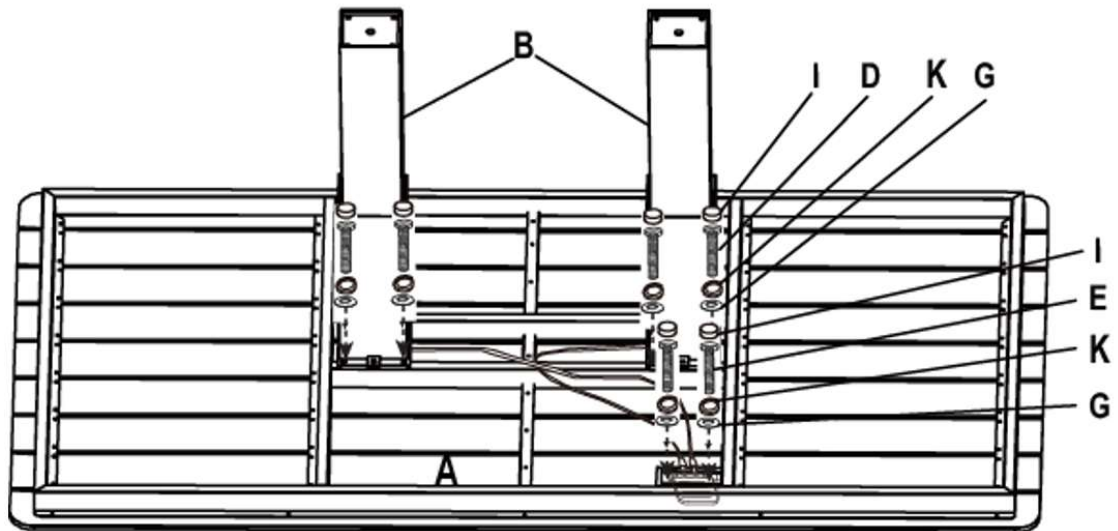

STEP 1: Attach leg pillar (B) to the table top (A), using the M6x25 bolt (D), lock washer (K) and washer (G).

STEP 2: Attach the handle to the Table top (A), using the M6x35 bolt (E), lock washer (K) and washer (G).
Tighten all the bolts and cover with the bolt cap (I)

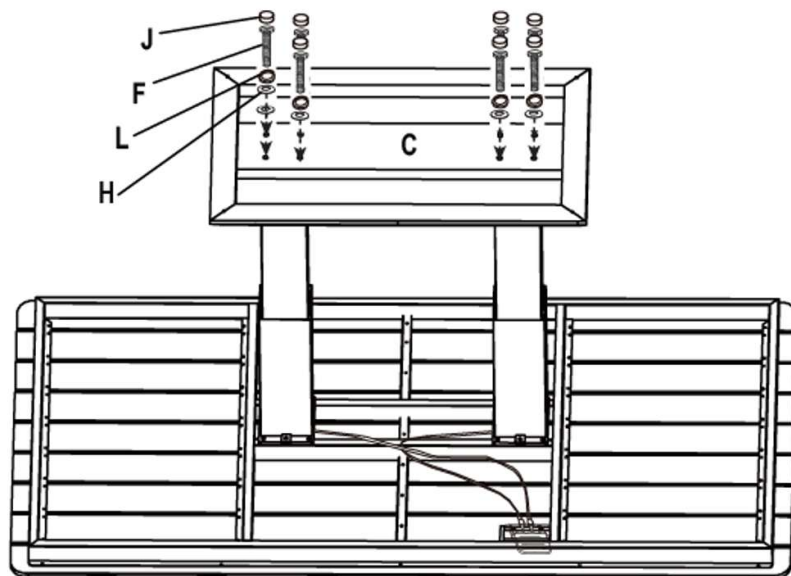

STEP 3: Attach base (C) to the leg pillar (B), using the M8x55 bolt (F), lock washer (L) and washer (H)
Tighten all the bolts and cover with the bolt cap (J)

STEP 4: ADJUSTING THE HEIGHT OF THE TABLE

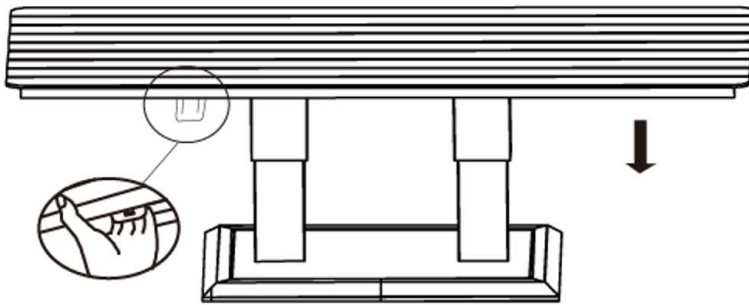
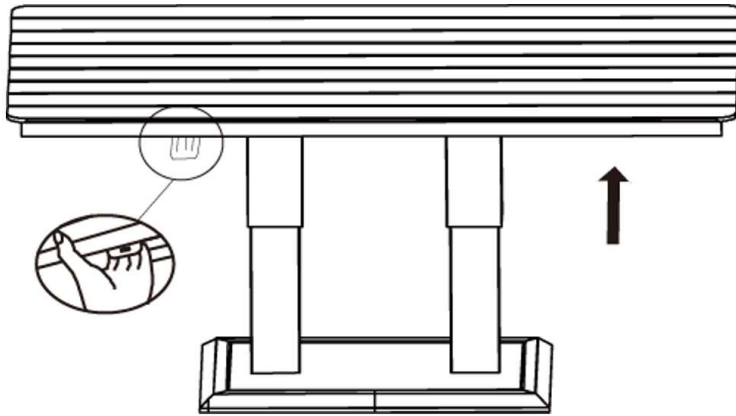
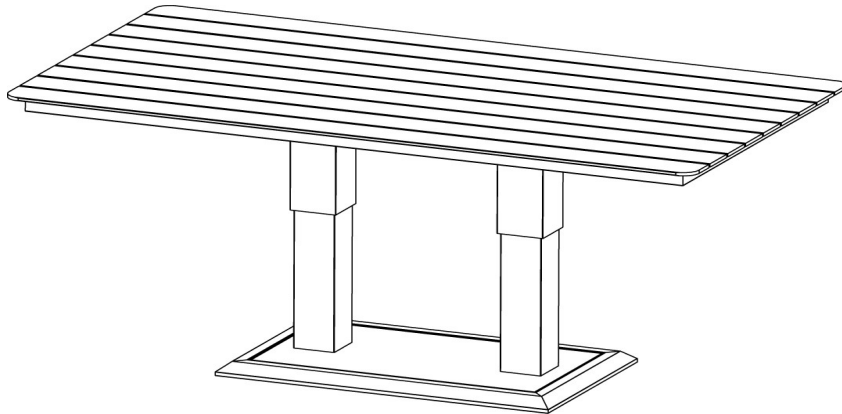

STEP 4: To raise the table, firmly squeeze the handle. To lower the table, gently press the centre of the tabletop while squeezing the handle.



Assembly Instructions

Sahara Side Table (Product Code: 64870099)







**PLEASE RETAIN THIS DOCUMENT ALONG WITH YOUR
PROOF OF PURCHASE FOR FUTURE REFERENCE**

Congratulations on your recent purchase of your beautiful Hartman furniture. We hope it brings you bountiful special moments with friends and family for many years to come. Please follow these simple steps to build your furniture. We also have a very useful video available online to assist with the assembly, please visit www.hartmanuk.com

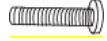
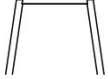
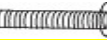
TOP TIPS

- Please read these instructions carefully before assembly. For further assistance please view our assembly video online for an easy step by step demonstration.
- Aluminium is a soft metal and over tightening may strip the thread or break the part, please loosely assemble your furniture before tightening to secure.
- Please **do not** use power tools, please only use the tools provided in the bolt pack.
- Please allow 1 hour for assembly
- This furniture can be assembled with **1** person; however, you may need someone to assist you when turning the furniture over into position.

PARTS LIST

Components					Fixings				
Parts List	Parts Picture	Description	Qty	Part No.	Parts List	Parts Picture	Description	Qty	Part No.
A		Table Top	1	64870099A	D		M6x35 Bolt	4	1111162
B		Leg 1	1	64870099B	E		M6x45 Bolt	4	1131162
C		Leg 2	1	64870099C	F		M6x65 Bolt	4	1061183
					G		M6 Bolt Cap	4	1061181
					H		M6x16 Washer	5	1061162
					I		M6 Allen Key	1	1010162
					J		Adjustable Foot (φ36)	4	1061184

STEP 1 & 2: LEGS ASSEMBLY

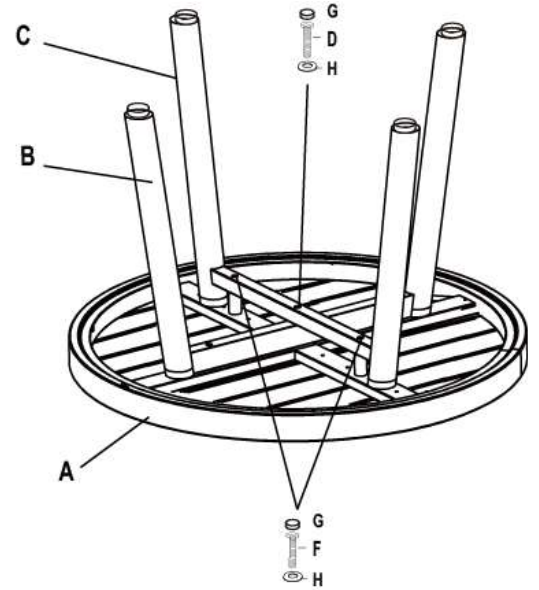
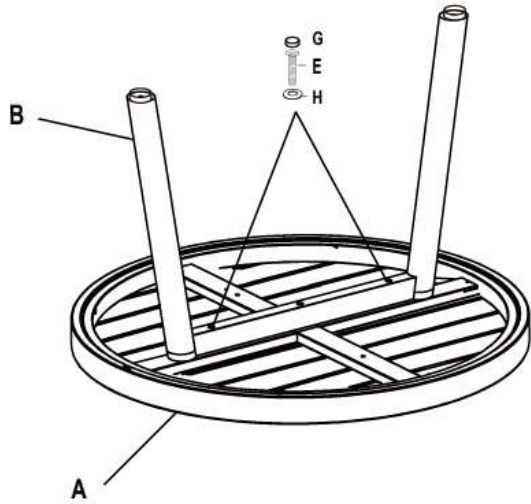

STEP 1: Attach leg 1 (B) to the table top (A) using bolt M6x45 Bolt (E), washer (H)

STEP 2: Attach leg 2 (C) to the table top (A) using bolt M6x65 Bolt (F), washer (H), and using bolt M6x35 Bolt (D), washer (H) to attach the leg 1 (B) & leg 2 (C)

STEP 3: TIGHTEN AND FINISHING

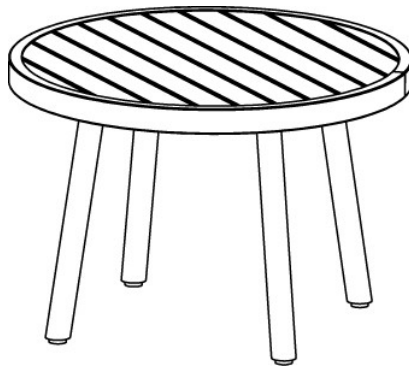

STEP 3: Tighten all the screws and covered with the bolt cap (G), turn over the table.