



Assembly Instructions

Sahara 4 Seat Round Set

(Product Codes: 64874099, 64871099)

**PLEASE RETAIN THIS DOCUMENT ALONG WITH YOUR
PROOF OF PURCHASE FOR FUTURE REFERENCE**

Congratulations on your recent purchase of your beautiful Hartman furniture. We hope it brings you countless special moments with friends and family for many years to come.

Please follow these simple steps to build your furniture. We also have a very useful video available online to assist with the assembly, please visit www.hartmanuk.com

TOP TIPS

- Please read these instructions carefully before assembly, for further assistance please view our assembly video online for an easy step by step demonstration.
- Aluminium is a soft metal and over tightening may strip the thread or break the part, please loosely assembly your furniture before tightening to secure.
- Please **do not** use power tools, only use the tools provided in the bolt pack.
- Please allow 1 hour for assembly.
- This furniture can be assembled with **1** person; however, you may need someone to assist you when turning the furniture over into position.



Assembly Instructions

Sahara 4 Seat Round Table (Product Code: 64874099)









**PLEASE RETAIN THIS DOCUMENT ALONG WITH YOUR
PROOF OF PURCHASE FOR FUTURE REFERENCE**

Congratulations on your recent purchase of your beautiful Hartman furniture. We hope it brings you bountiful special moments with friends and family for many years to come. Please follow these simple steps to build your furniture. We also have a very useful video available online to assist with the assembly, please visit www.hartmanuk.com

TOP TIPS

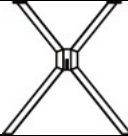
- Please read these instructions carefully before assembly. For further assistance please view our assembly video online for an easy step by step demonstration.
- Aluminium is a soft metal and over tightening may strip the thread or break the part, please loosely assemble your furniture before tightening to secure.
- Please **do not** use power tools, please only use the tools provided in the bolt pack.
- Please allow 1 hour for assembly.
- This furniture can be assembled with **2** people; however, you may need someone to assist you when turning the furniture over into position.

PARTS LIST

Components					Fixings				
Parts List	Parts Picture	Description	Qty	Part No.	Parts List	Parts Picture	Description	Qty	Part No.
A		Table Top	1	64874099A	E		M6x16 Washer	4	1061162
B		Leg 1	1	64874099B	F		M6x20 Bolt	4	1091162
C		Leg 2	1	64874099C	G		M6 Bolt Cap	4	1061181
D		Parasol Reducer Ring & Cap	1	64874099D	H		M6 Allen Key	1	1010162
					I		Adjustable Foot (φ32)	4	1061193

STEP 1 & 2: LEGS ASSEMBLY

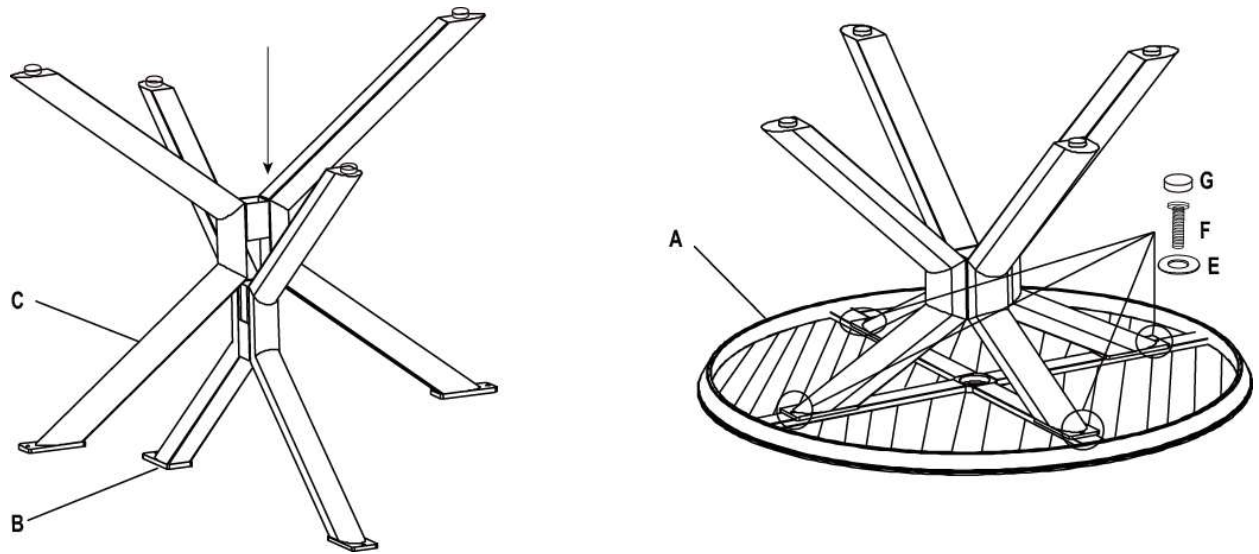

STEP 1&2: Inset leg2 (C) into leg1 (B)
Then attach it on the bottom of table top frame (A), using bolt (F), washer (E).
Tighten all the bolts and finish with the bolt cap (G)

STEP 3: FINISHING

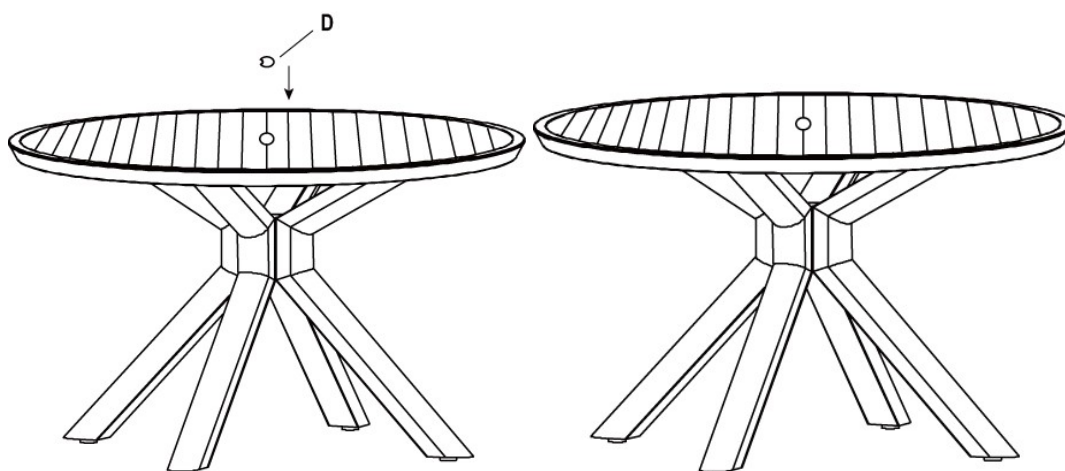

STEP 3: Turn the table over and place the parasol reducer ring & cap (D) into the hole.



Assembly Instructions

Sahara Dining Chair (Product Code: 64871099)









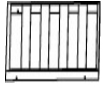

**PLEASE RETAIN THIS DOCUMENT ALONG WITH YOUR
PROOF OF PURCHASE FOR FUTURE REFERENCE**

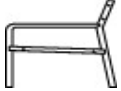
Congratulations on your recent purchase of your beautiful Hartman furniture. We hope it brings you bountiful special moments with friends and family for many years to come. Please follow these simple steps to build your furniture. We also have a very useful video available online to assist with the assembly, please visit www.hartmanuk.com

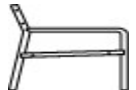
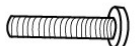
TOP TIPS

- Please read these instructions carefully before assembly. For further assistance please view our assembly video online for an easy step by step demonstration.
- Aluminium is a soft metal and over tightening may strip the thread or break the part, please loosely assemble your furniture before tightening to secure.
- Please **do not** use power tools, please only use the tools provided in the bolt pack.
- Please allow 1 hour for assembly.
- This furniture can be assembled with 1 person; however, you may need someone to assist you when turning the furniture over into position.

PARTS LIST

Components					Fixings				
Parts List	Parts Picture	Description	Qty	Part No.	Parts List	Parts Picture	Description	Qty	Part No.
A		Seat Frame	1	64871099A	G		M6x16 Washer	4	1061162
B		Armrest 1	1	64871099B	H		M6x25 Flat Head Screw	4	1061182
C		Armrest 2	1	64871099C	I		M6x30 Bolt	4	1101162
D		Backrest	1	64871099D	J		M6 Bolt Cap	4	1061181
E		Seat Cushion	1	64871099E	K		M6 Allen Key	1	1010162
F		Back Cushion	1	64871099F	L		Adjustable Foot (φ36)	4	1061184

STEP 1 & 2: ARMREST AND BACKREST ASSEMBLY

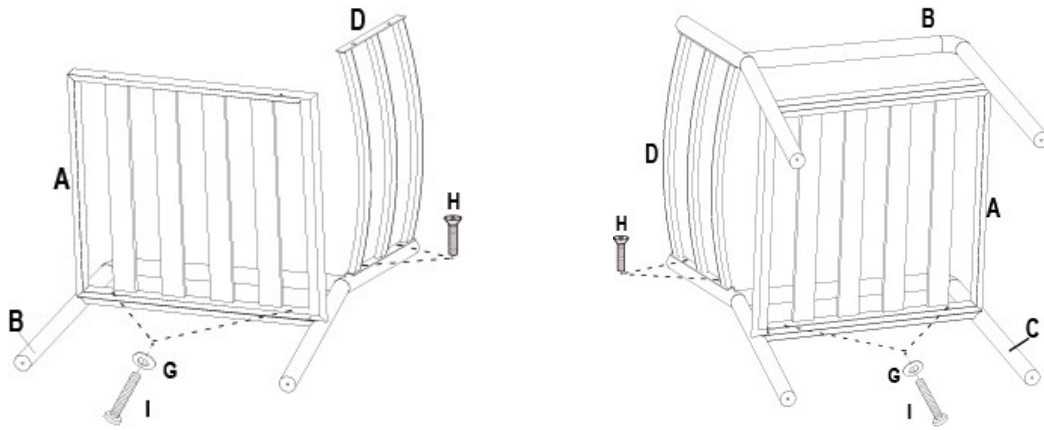

STEP 1: Attach armrest 1 (B) to the seat frame (A) using the M6x30 Bolt (I) and Washer (G)

Attach backrest (D) to the seat frame (A) using the bolt M6x25 (H).

STEP 2: Repeat step 1 to attach the armrest 2 (C) to the seat frame and backrest.

STEP 3: TIGHTENING AND FINISHING

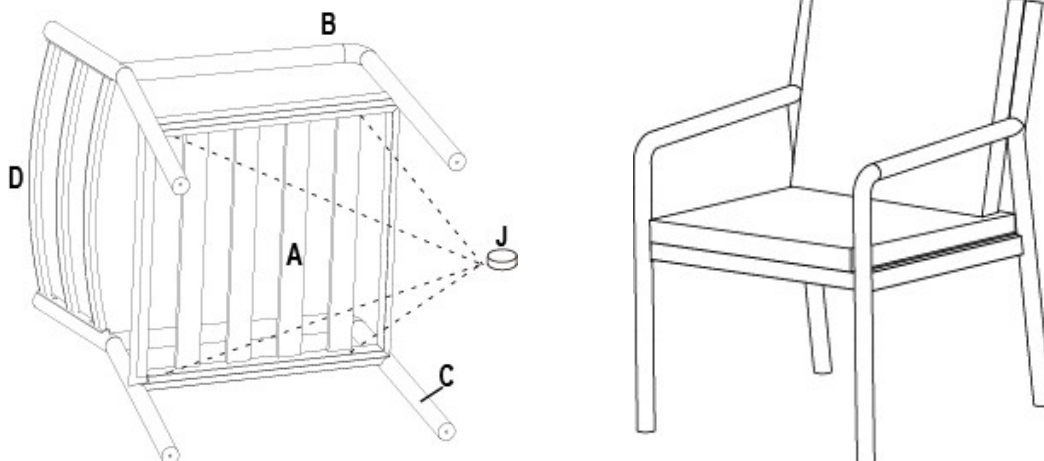

STEP 3: Tighten all the bolts on the chair and cover with the plastic bolt cap (J). Turn the chair over and place the seat cushion (E) and the back cushion (F) onto the chair.