



Assembly Instructions

Sahara Square Casual Dining Set with Square Adjustable Table

(Product Codes: 64854099, 64851099, 64852099)

**PLEASE RETAIN THIS DOCUMENT ALONG WITH YOUR
PROOF OF PURCHASE FOR FUTURE REFERENCE**

Congratulations on your recent purchase of your beautiful Hartman furniture. We hope it brings you countless special moments with friends and family for many years to come.

Please follow these simple steps to build your furniture. We also have a very useful video available online to assist with the assembly, please visit www.hartmanuk.com

TOP TIPS

- Please read these instructions carefully before assembly, for further assistance please view our assembly video online for an easy step by step demonstration.
- Aluminium is a soft metal and over tightening may strip the thread or break the part, please loosely assembly your furniture before tightening to secure.
- Please **do not** use power tools, only use the tools provided in the bolt pack.
- Please allow 1 hour for assembly.
- This furniture can be assembled with **1** person; however, you may need someone to assist you when turning the furniture over into position.



Assembly Instructions

Sahara Square Corner Sofa Unit **(Product Code: 64854099)**













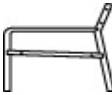

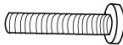

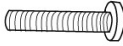
**PLEASE RETAIN THIS DOCUMENT ALONG WITH YOUR
PROOF OF PURCHASE FOR FUTURE REFERENCE**

Congratulations on your recent purchase of your beautiful Hartman furniture. We hope it brings you bountiful special moments with friends and family for many years to come. Please follow these simple steps to build your furniture. We also have a very useful video available online to assist with the assembly, please visit www.hartmanuk.com

TOP TIPS

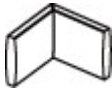
- Please read these instructions carefully before assembly. For further assistance please view our assembly video online for an easy step by step demonstration.
- Aluminium is a soft metal and over tightening may strip the thread or break the part, please loosely assemble your furniture before tightening to secure.
- Please **do not** use power tools, please only use the tools provided in the bolt pack
- Please allow 1 hour for assembly
- This furniture can be assembled with **2** people; however, you may need someone to assist you when turning the furniture over into position.

PARTS LIST - LEFT HAND CORNER

| Components | | | | | Fixings | | | | |
|------------|---|---------------------|-----|-----------|------------|---|-----------------------|-----|----------|
| Parts List | Parts Picture | Description | Qty | Part No. | Parts List | Parts Picture | Description | Qty | Part No. |
| A |  | Seat Frame 1 | 1 | 64854099A | N |  | M6x16 Washer | 12 | 1061162 |
| B |  | Armrest 1 | 1 | 64854099B | O |  | M6x25 Bolt | 4 | 1061182 |
| C |  | Backrest 1 | 1 | 64854099C | P |  | M6x35 Bolt | 8 | 1111162 |
| D |  | Backrest 2 | 1 | 64854099D | Q |  | M6x40 Bolt | 4 | 1121162 |
| E |  | Centre Leg 1 | 1 | 64854099E | R |  | Bolt Cap | 12 | 1061181 |
| F |  | Seat Cushion | 3 | 64854099F | S |  | M6 Allen Key | 1 | 1010162 |
| G |  | Back Cushion | 2 | 64854099G | T |  | Frame Plug | 2 | 1061185 |
| H |  | Back Corner Cushion | 1 | 64854099H | U |  | Adjustable Foot (φ36) | 2 | 1061184 |
| Y |  | Velcro | 2 | 2200011 | V |  | Adjustable Foot (φ45) | 3 | 1061180 |
| | | | | | W |  | Adjustable Foot | 1 | 1061187 |

STEP 1 - 4: FRAME ASSEMBLY - RIGHT HAND

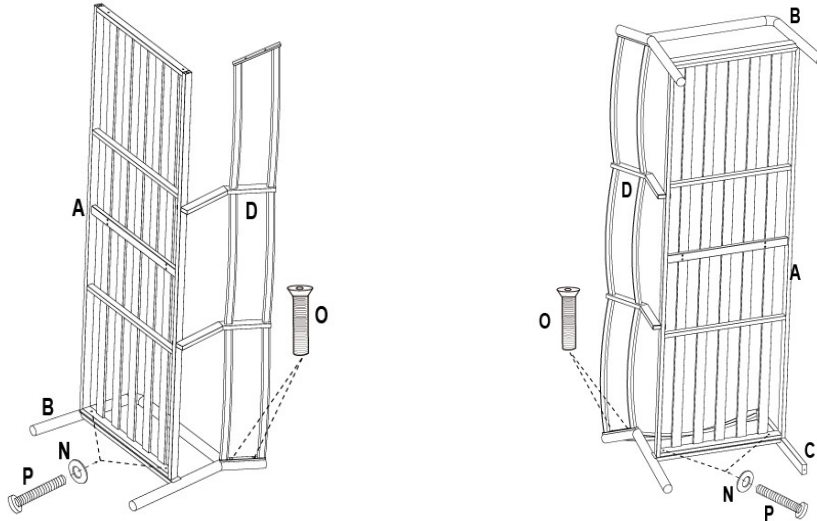

STEP 1: Attach armrest 1 (B) to the seat frame 1 (A) using the bolt M6x35 (P) and washer (N)
Attach backrest 2 (D) to the seat frame 1 (A) using the bolt M6x25 (O)



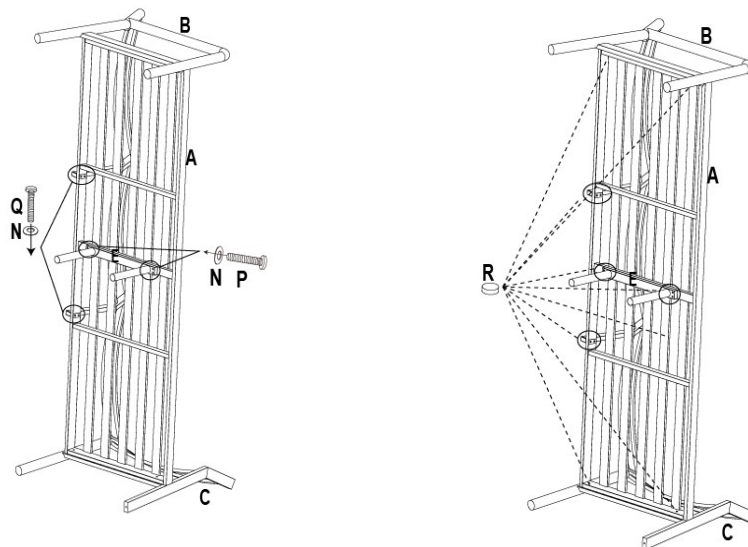









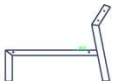

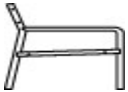
STEP 2: Repeat step 1 to attach the backrest 1 (C) to the seat frame 1 (A) and backrest 2 (D)

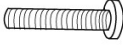
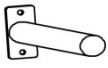
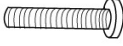

STEP 3: Attach backrest 2 (D) to the seat frame 1 (A) using the bolt M6x40 (Q) and washer (N)

STEP 4: Attach centre leg 1 (E) to the seat frame 1 (A) using the bolt M6x35 (P) and washer (N)
Tighten all the bolts and cover with the bolt caps (R).
Turn the sofa over.

PARTS LIST - RIGHT HAND CORNER

| Components | | | | | Fixings | | | | |
|------------|---|-----------------|-----|-----------|------------|---|-----------------------|-----|----------|
| Parts List | Parts Picture | Description | Qty | Part No. | Parts List | Parts Picture | Description | Qty | Part No. |
| I |  | Seat Frame 2 | 1 | 64854099I | N |  | M6x16 Washer | 12 | 1061162 |
| J |  | Leg | 1 | 64854099J | O |  | M6x25 Bolt | 4 | 1061182 |
| K |  | Armrest 2 | 1 | 64854099K | X |  | M6x20 Bolt | 2 | 1091162 |
| L |  | Backrest 3 | 1 | 64854099L | P |  | M6x35 Bolt | 4 | 1111162 |
| M |  | Centre Leg 2 | 1 | 64854099M | Q |  | M6x40 Bolt | 2 | 1121162 |
| F |  | Seat Cushion | 2 | 64854099F | R |  | Bolt Cap | 2 | 1061181 |
| G |  | Back Cushion | 2 | 64854099G | S |  | M6 Allen Key | 2 | 1010162 |
| W |  | Adjustable Feet | 1 | 1061187 | U |  | Adjustable Foot (φ36) | 1 | 1061184 |
| T |  | Push in Foot | 1 | 1061185 | V |  | Adjustable Foot (φ45) | 3 | 1061180 |

STEP 5 - 8: FRAME ASSEMBLY - LEFT HAND

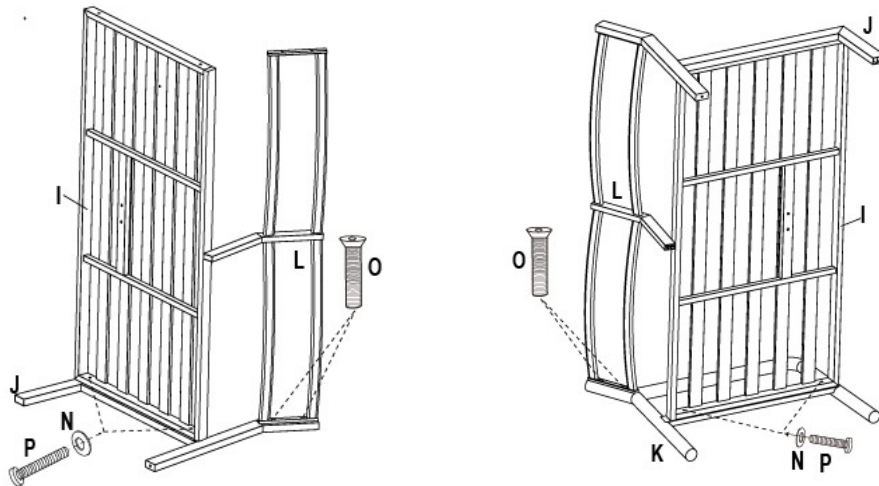

STEP 5: Attach seat frame 2 (I) to the leg (J) using the bolt M6x35 (P) and washer (N)
Attach backrest 3 (L) to the seat frame 2 (I) using the bolt M6x25 (O)

STEP 6: Repeat step 5 to attach the armrest 2 (K) to the seat frame 2 (I) and backrest 3 (L)

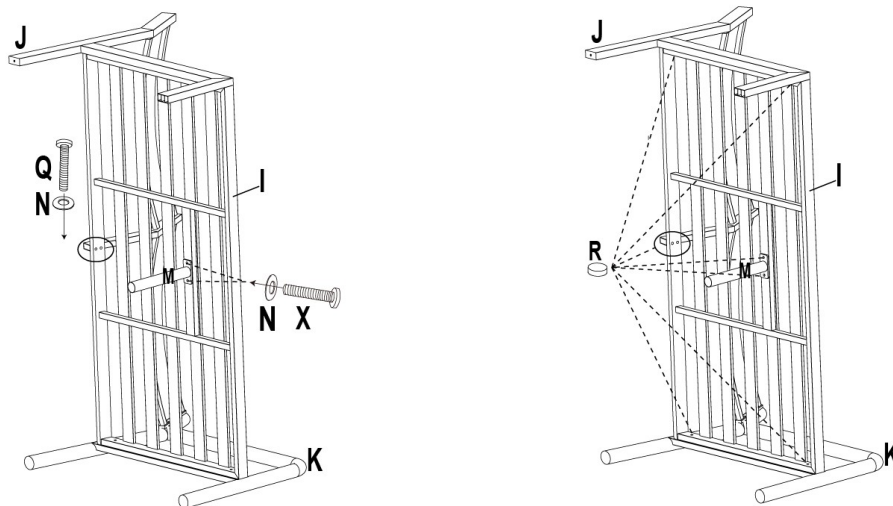

STEP 7: Attach backrest (J) to the seat frame 2 (I) using the bolt M6x40 (Q) and washer (N)

STEP 8: Attach centre leg 2 (M) to the seat frame 2 (I) using the bolt M6x20 (X) and washer (N)
Tighten all the bolts and cover with the bolt caps (R).

Turn the sofa over.

STEP 9: TIGHTEN AND FINISHING

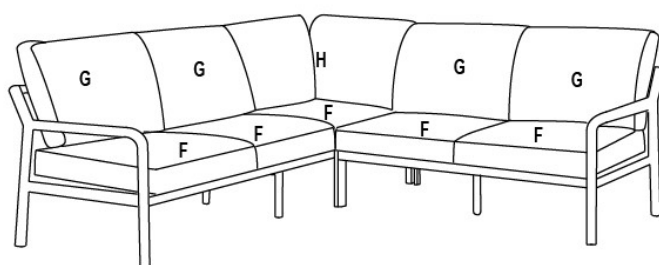
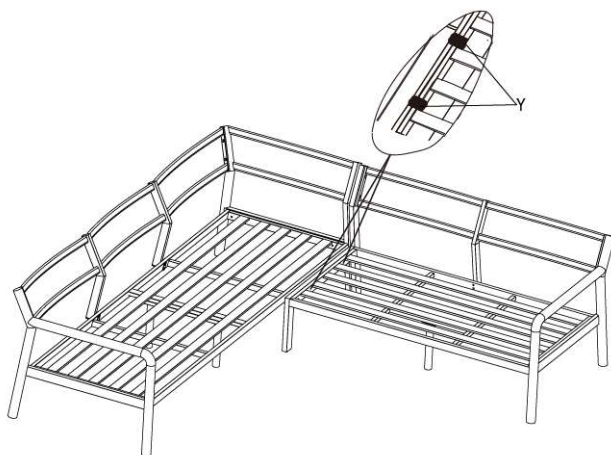

STEP 9: Connect the righthand and lefthand sofa using the Velcro (Y).
Place the seat cushions (F), back cushions (G) and the corner back cushion (H)
onto the sofa.



Assembly Instructions

Sahara 100cm Square Adjustable Table (Product Codes: 64851099 & 64852099)













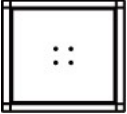

**PLEASE RETAIN THIS DOCUMENT ALONG WITH YOUR
PROOF OF PURCHASE FOR FUTURE REFERENCE**

Congratulations on your recent purchase of your beautiful Hartman furniture. We hope it brings you bountiful special moments with friends and family for many years to come. Please follow these simple steps to build your furniture. We also have a very useful video available online to assist with the assembly, please visit www.hartmanuk.com

TOP TIPS

- Please read these instructions carefully before assembly. For further assistance please view our assembly video online for an easy step by step demonstration.
- Aluminium is a soft metal and over tightening may strip the thread or break the part, please loosely assemble your furniture before tightening to secure.
- Please **do not** use power tools, please only use the tools provided in the bolt pack.
- Please allow 1 hour for assembly
- This furniture can be assembled with **2** people; however, you may need someone to assist you when turning the furniture over into position.

PARTS LIST

| Components | | | | | Fixings | | | | |
|------------|---|-------------|-----|-----------|------------|---|-----------------|-----|----------|
| Parts List | Parts Picture | Description | Qty | Part No. | Parts List | Parts Picture | Description | Qty | Part No. |
| A |  | Table Top | 1 | 64851099A | D |  | M6x25 Washer | 4 | 1017162 |
| B |  | Leg Pillar | 1 | 64852099B | E |  | M6x35 Washer | 2 | 1111162 |
| C |  | Base | 1 | 64851099C | F |  | M8x55 Bolt | 4 | 2002166 |
| | | | | | G |  | M6* φ 12 Washer | 6 | 1241162 |
| | | | | | H |  | M8* φ 20 Washer | 4 | 1061191 |
| | | | | | I |  | M6 Bolt Cap | 6 | 1061181 |
| | | | | | J |  | M8 Bolt Cap | 4 | 1061186 |
| | | | | | K |  | M6 Lock Washer | 6 | 1051163 |
| | | | | | L |  | M8 Lock Washer | 4 | 1063162 |
| | | | | | M |  | M6 Allen Key | 1 | 1010162 |
| | | | | | N |  | M8 Allen Key | 1 | 1051162 |
| | | | | | O |  | Adjustable Foot | 4 | 1061187 |

STEP 1 & 3: PILLAR ASSEMBLY

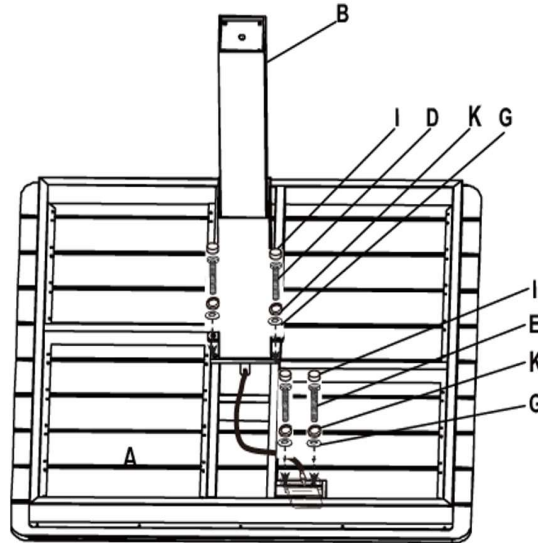

STEP 1: Attach leg pillar (B) to the table top (A), using the M6x25 bolt (D), lock washer (K) and washer (G).

STEP 2: Attach the handle to the Table top (A), using the M6x35 bolt (E), lock washer (K) and washer (G).
Tighten all the bolts and cover with the bolt cap (I)

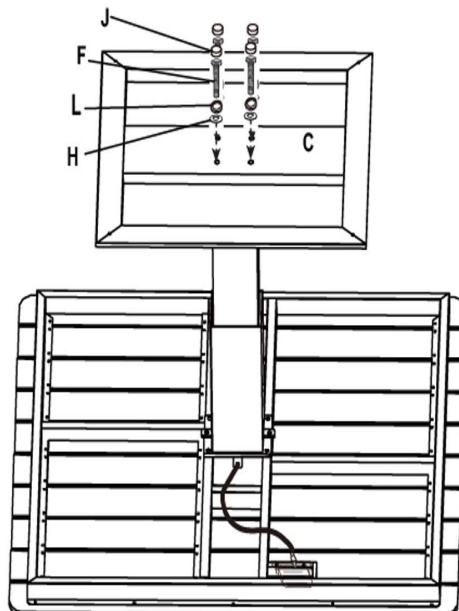

STEP 3: Attach base (C) to the leg pillar (B), using the M8x55 bolt (F), lock washer (L) and washer (H)
Tighten all the bolts and cover with the bolt cap (J)

STEP 4: ADJUSTING THE HEIGHT OF THE TABLE

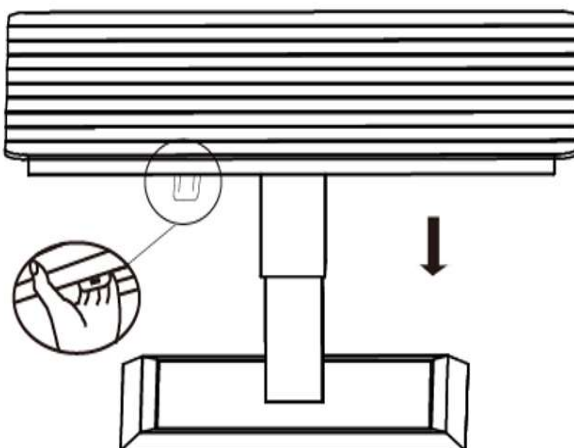
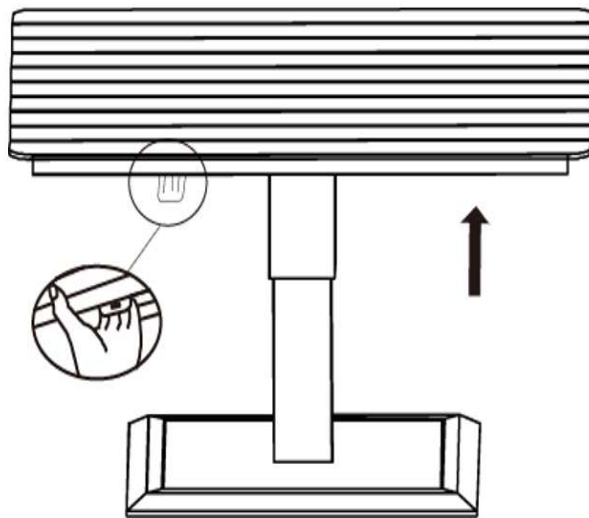
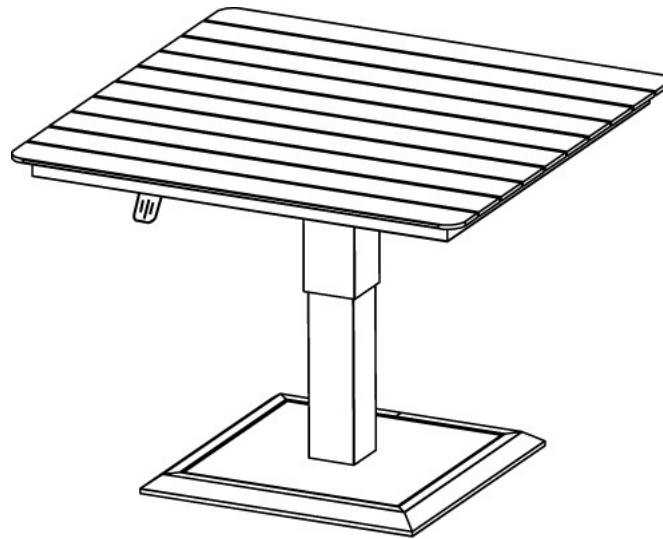

STEP 4: To raise the table, firmly squeeze the handle. To lower the table, gently press the centre of the tabletop while squeezing the handle.