



Assembly Instructions

Sahara Square Casual Dining Set with Square Coffee Table

(Product Codes: 64854099, 64853099)

**PLEASE RETAIN THIS DOCUMENT ALONG WITH YOUR
PROOF OF PURCHASE FOR FUTURE REFERENCE**

Congratulations on your recent purchase of your beautiful Hartman furniture. We hope it brings you countless special moments with friends and family for many years to come.

Please follow these simple steps to build your furniture. We also have a very useful video available online to assist with the assembly, please visit www.hartmanuk.com

TOP TIPS

- Please read these instructions carefully before assembly, for further assistance please view our assembly video online for an easy step by step demonstration.
- Aluminium is a soft metal and over tightening may strip the thread or break the part, please loosely assembly your furniture before tightening to secure.
- Please **do not** use power tools, only use the tools provided in the bolt pack.
- Please allow 1 hour for assembly.
- This furniture can be assembled with **1** person; however, you may need someone to assist you when turning the furniture over into position.



Assembly Instructions

Sahara Square Corner Sofa Unit (Product Code: 64854099)













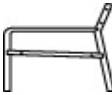

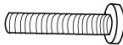

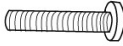
**PLEASE RETAIN THIS DOCUMENT ALONG WITH YOUR
PROOF OF PURCHASE FOR FUTURE REFERENCE**

Congratulations on your recent purchase of your beautiful Hartman furniture. We hope it brings you bountiful special moments with friends and family for many years to come. Please follow these simple steps to build your furniture. We also have a very useful video available online to assist with the assembly, please visit www.hartmanuk.com

TOP TIPS

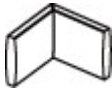
- Please read these instructions carefully before assembly. For further assistance please view our assembly video online for an easy step by step demonstration.
- Aluminium is a soft metal and over tightening may strip the thread or break the part, please loosely assemble your furniture before tightening to secure.
- Please **do not** use power tools, please only use the tools provided in the bolt pack
- Please allow 1 hour for assembly
- This furniture can be assembled with **2** people; however, you may need someone to assist you when turning the furniture over into position.

PARTS LIST - LEFT HAND CORNER

Components					Fixings				
Parts List	Parts Picture	Description	Qty	Part No.	Parts List	Parts Picture	Description	Qty	Part No.
A		Seat Frame 1	1	64854099A	N		M6x16 Washer	12	1061162
B		Armrest 1	1	64854099B	O		M6x25 Bolt	4	1061182
C		Backrest 1	1	64854099C	P		M6x35 Bolt	8	1111162
D		Backrest 2	1	64854099D	Q		M6x40 Bolt	4	1121162
E		Centre Leg 1	1	64854099E	R		Bolt Cap	12	1061181
F		Seat Cushion	3	64854099F	S		M6 Allen Key	1	1010162
G		Back Cushion	2	64854099G	T		Frame Plug	2	1061185
H		Back Corner Cushion	1	64854099H	U		Adjustable Foot (φ36)	2	1061184
Y		Velcro	2	2200011	V		Adjustable Foot (φ45)	3	1061180
					W		Adjustable Foot	1	1061187

STEP 1 - 4: FRAME ASSEMBLY - RIGHT HAND

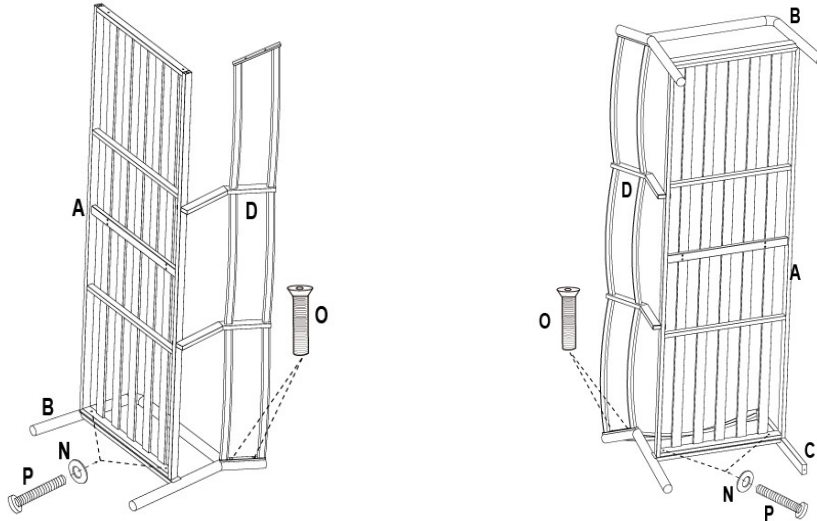

STEP 1: Attach armrest 1 (B) to the seat frame 1 (A) using the bolt M6x35 (P) and washer (N)
Attach backrest 2 (D) to the seat frame 1 (A) using the bolt M6x25 (O)



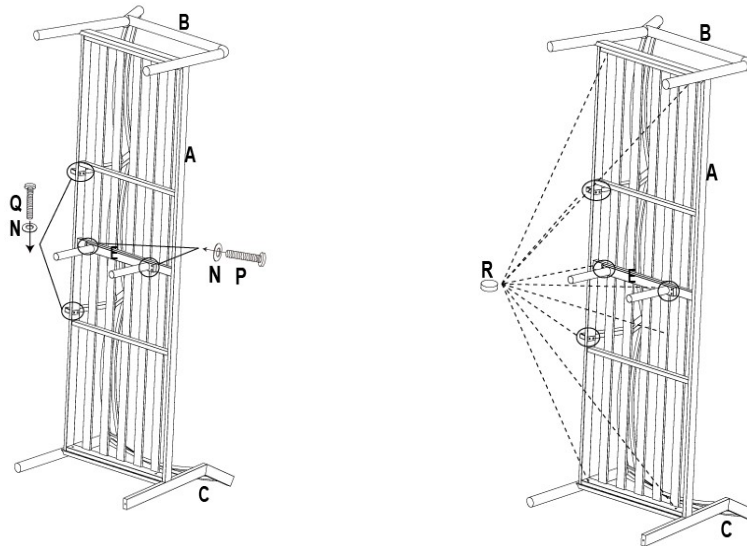









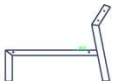

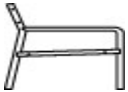
STEP 2: Repeat step 1 to attach the backrest 1 (C) to the seat frame 1 (A) and backrest 2 (D)

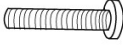
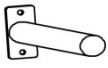
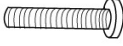

STEP 3: Attach backrest 2 (D) to the seat frame 1 (A) using the bolt M6x40 (Q) and washer (N)

STEP 4: Attach centre leg 1 (E) to the seat frame 1 (A) using the bolt M6x35 (P) and washer (N)
Tighten all the bolts and cover with the bolt caps (R).
Turn the sofa over.

PARTS LIST - RIGHT HAND CORNER

Components					Fixings				
Parts List	Parts Picture	Description	Qty	Part No.	Parts List	Parts Picture	Description	Qty	Part No.
I		Seat Frame 2	1	64854099I	N		M6x16 Washer	12	1061162
J		Leg	1	64854099J	O		M6x25 Bolt	4	1061182
K		Armrest 2	1	64854099K	X		M6x20 Bolt	2	1091162
L		Backrest 3	1	64854099L	P		M6x35 Bolt	4	1111162
M		Centre Leg 2	1	64854099M	Q		M6x40 Bolt	2	1121162
F		Seat Cushion	2	64854099F	R		Bolt Cap	2	1061181
G		Back Cushion	2	64854099G	S		M6 Allen Key	2	1010162
W		Adjustable Feet	1	1061187	U		Adjustable Foot (φ36)	1	1061184
T		Push in Foot	1	1061185	V		Adjustable Foot (φ45)	3	1061180

STEP 5 - 8: FRAME ASSEMBLY - LEFT HAND

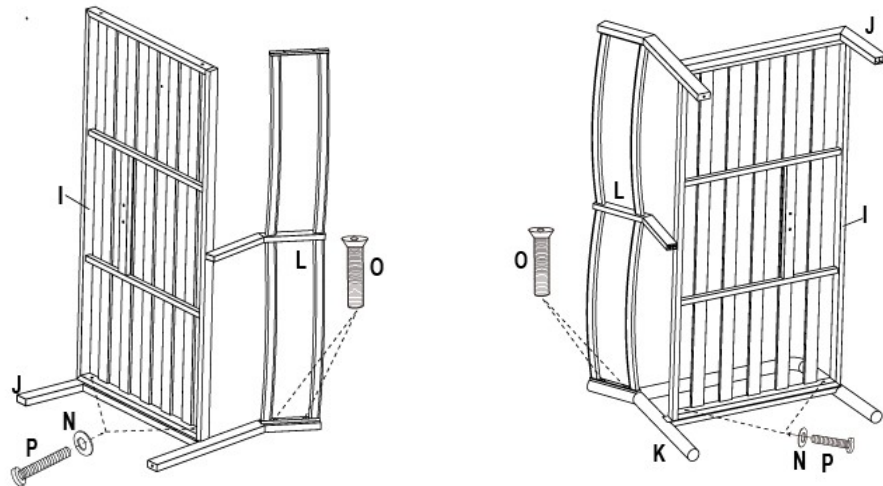

STEP 5: Attach seat frame 2 (I) to the leg (J) using the bolt M6x35 (P) and washer (N)
Attach backrest 3 (L) to the seat frame 2 (I) using the bolt M6x25 (O)

STEP 6: Repeat step 5 to attach the armrest 2 (K) to the seat frame 2 (I) and backrest 3 (L)

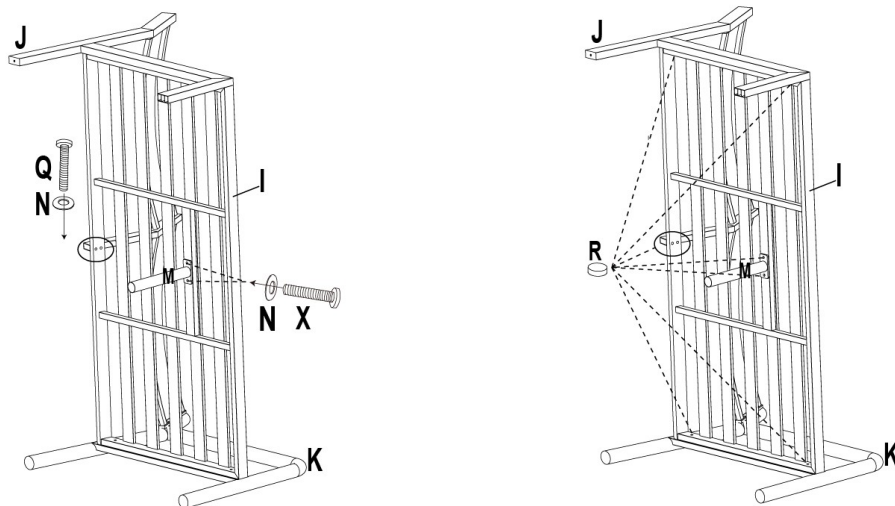

STEP 7: Attach backrest (J) to the seat frame 2 (I) using the bolt M6x40 (Q) and washer (N)

STEP 8: Attach centre leg 2 (M) to the seat frame 2 (I) using the bolt M6x20 (X) and washer (N)
Tighten all the bolts and cover with the bolt caps (R).
Turn the sofa over.

STEP 9: TIGHTEN AND FINISHING

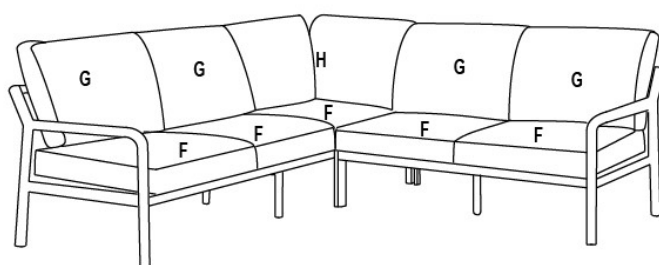
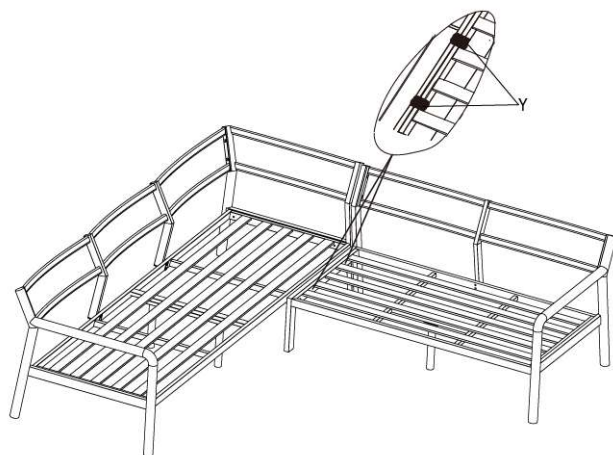

STEP 9: Connect the righthand and lefthand sofa using the Velcro (Y).
Place the seat cushions (F), back cushions (G) and the corner back cushion (H)
onto the sofa.



Assembly Instructions

Sahara 100cm Square Coffee Table (Product Code: 64853099)









**PLEASE RETAIN THIS DOCUMENT ALONG WITH YOUR
PROOF OF PURCHASE FOR FUTURE REFERENCE**

Congratulations on your recent purchase of your beautiful Hartman furniture. We hope it brings you bountiful special moments with friends and family for many years to come. Please follow these simple steps to build your furniture. We also have a very useful video available online to assist with the assembly, please visit www.hartmanuk.com

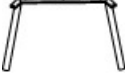
TOP TIPS

- Please read these instructions carefully before assembly. For further assistance please view our assembly video online for an easy step by step demonstration.
- Aluminium is a soft metal and over tightening may strip the thread or break the part, please loosely assemble your furniture before tightening to secure.
- Please **do not** use power tools, please only use the tools provided in the bolt pack
- Please allow 1 hour for assembly
- This furniture can be assembled with **2** people; however, you may need someone to assist you when turning the furniture over into position.

PARTS LIST

Components					Fixings				
Parts List	Parts Picture	Description	Qty	Part No.	Parts List	Parts Picture	Description	Qty	Part No.
A		Table Top	1	64853099A	C		M6x16 Washer	10	1061162
B		Leg	2	64853099B	D		M6x30 Bolt	10	1111162
					E		M6 Bolt Cap	10	1061181
					F		M6 Allen Key	1	1010162
					G		M6 Lock Washer	10	1051163
					H		Adjustable Foot (φ45)	4	1061180

STEP 1 & 2: LEGS ASSEMBLY

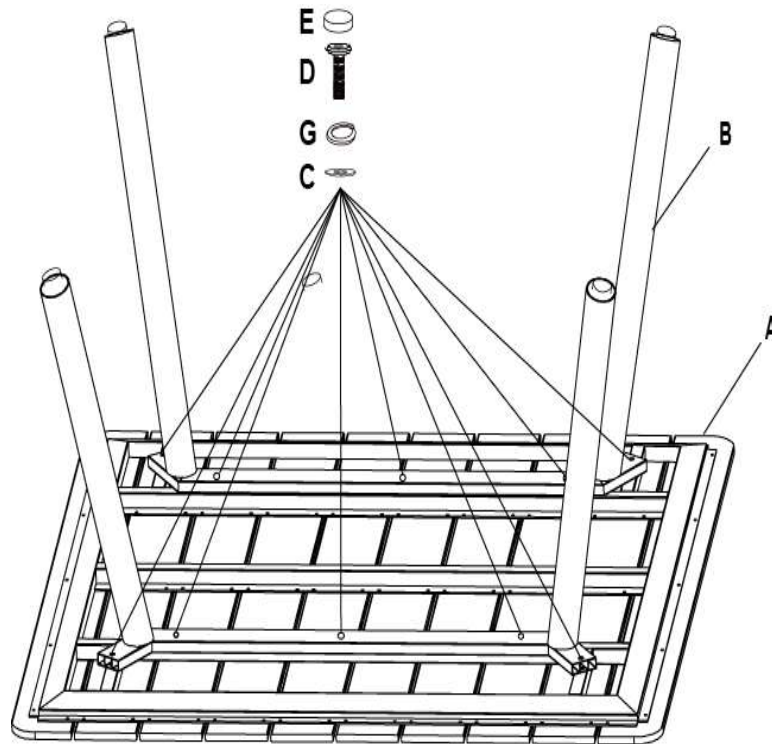

STEP 1: Attach leg (B) to the table top (A) using bolt M6x30 bolt (D), lock washer (G), washer(C)

STEP 2: TIGHTEN AND FINISHING

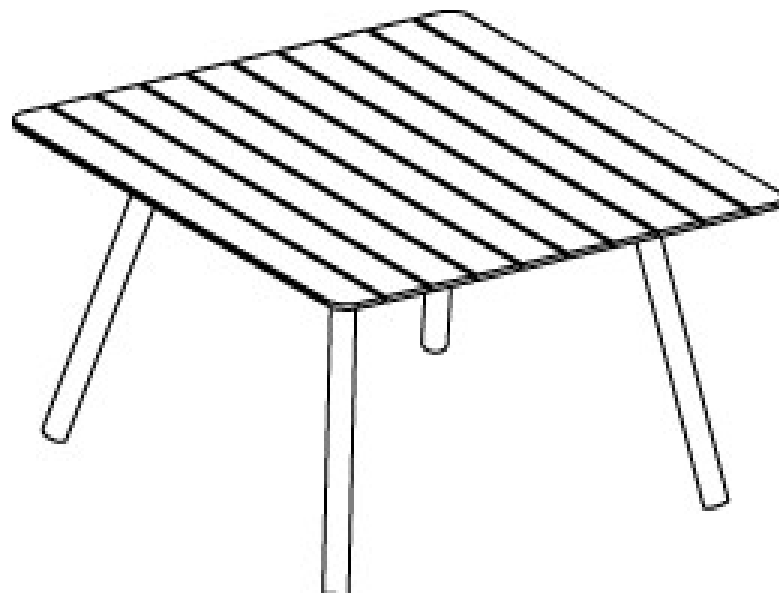

STEP 2: Tighten all the screws and covered with the bolt cap (E), turn over the table.