



Assembly Instructions

Sonas Rectangular Casual Dining Set

(Product Codes: 69127062, 69127018,
69125062 & 69126062)

**PLEASE RETAIN THIS DOCUMENT ALONG WITH YOUR
PROOF OF PURCHASE FOR FUTURE REFERENCE**

Congratulations on your recent purchase of your beautiful Hartman furniture. We hope it brings you countless special moments with friends and family for many years to come.

Please follow these simple steps to build your furniture. We also have a very useful video available online to assist with the assembly, please visit www.hartmanuk.com

TOP TIPS

- Please read these instructions carefully before assembly, for further assistance please view our assembly video online for an easy step by step demonstration.
- Aluminium is a soft metal and over tightening may strip the thread or break the part, please loosely assembly your furniture before tightening to secure.
- Please **do not** use power tools, only use the tools provided in the bolt pack.
- Please allow 1 hour for assembly.
- This furniture can be assembled with **1** person; however, you may need someone to assist you when turning the furniture over into position.



Assembly Instructions

Sonas Rectangular Corner Sofa Unit

(Product Codes: 69127062 / 69127018)

**PLEASE RETAIN THIS DOCUMENT ALONG WITH YOUR
PROOF OF PURCHASE FOR FUTURE**















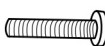

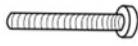



Congratulations on your recent purchase of your beautiful Hartman furniture. We hope it brings you countless special moments with friends and family for many years to come.

Please follow these simple steps to build your furniture. We also have a very useful video available online to assist with the assembly, please visit www.hartmanuk.com

TOP TIPS

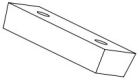
- Please read these instructions carefully before assembly, for further assistance please view our assembly video online for an easy step by step demonstration.
- Aluminium is a soft metal and over tightening may strip the thread or break the part, please loosely assembly your furniture before tightening to secure.
- Please **do not** use power tools, only use the tools provided in the bolt pack.
- Please allow 1 hour for assembly.
- This furniture can be assembled with **2** person; however, you may need someone to assist you when turning the furniture over into position.

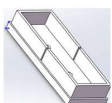
PARTS LIST - RIGHT HAND CORNER

Components					Fixings				
Parts List	Parts Picture	Description	Qty	Part No.	Parts List	Parts Picture	Description	Qty	Part No.
A		Seat Frame	1	69127062A 69127018A	M		Washer (M6*φ16)	14	1061162
B		Armrest 1	1	69127062B 69127018B	N		M6x20 Bolt	2	1091162
C		Back Rest 1	1	69127062C 69127018C	O		M6x35 Bolt	2	1111162
D		Back Rest 2	1	69127062D 69127018D	P		M6x45 Bolt	10	1131162
E		Centre Leg	1	69127062E 69127018E	Q		M6x55 Bolt	2	1641162
F		Back Cushion	2	69127062F 69127018F	R		M6 Allen Key	2	1010162
G		Corner Back Cushion	1	69127062G 69127018G	S		Plastic Bolt Cap	16	1061163
H		Seat Cushion	2	69127062H 69127018H	T		Washer (M6*φ12)	2	1241162
I		Corner Seat Cushion	1	69127062I 69127018I	U		M6 Lock Washer	16	1051163
X		Footpad	2	2SIF002	V		Velcro	2	2200011
Y		Footpad	2	2PIF001					
Z		Adjustable Footpad	1	2PIF004					

STEP 1 - 4: FRAME ASSEMBLY - RIGHT HAND CORNER

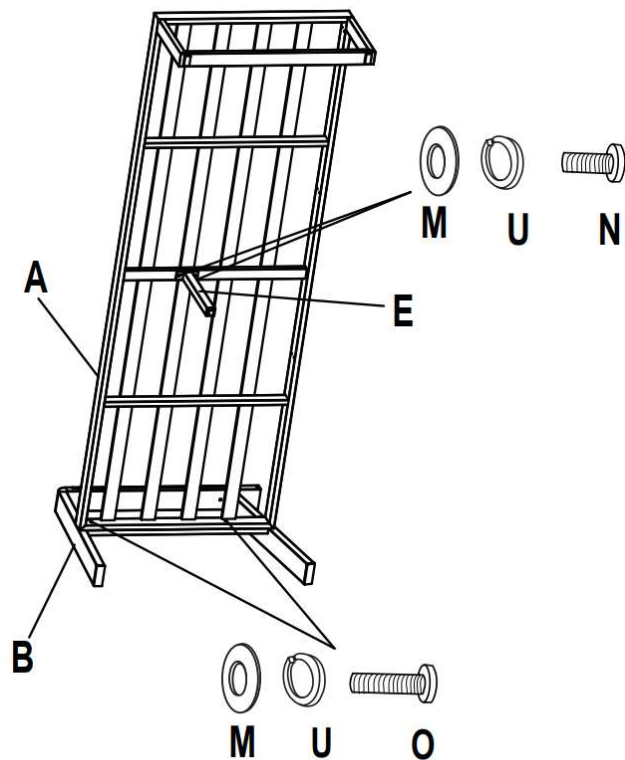

STEP 1: Attach Armrest 1 (B) to the Seat Frame 1 (A) using the M6x35 Bolt (O), Lock washer (U) and Washer (M).

Attach centre support leg (E) to the Seat Frame 1 (A) using the M6x20 Bolt (N), Lock washer (U) and Washer (M)

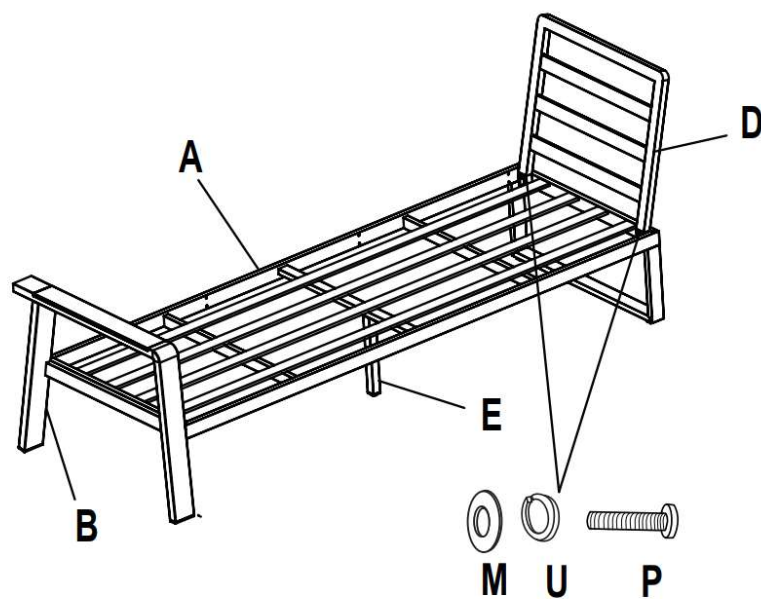

STEP 2: Attach Back Rest 2 (D) to the Seat Frame 1 (A) using the M6x45 Bolt (P), Lock washer (U) and Washer (M)

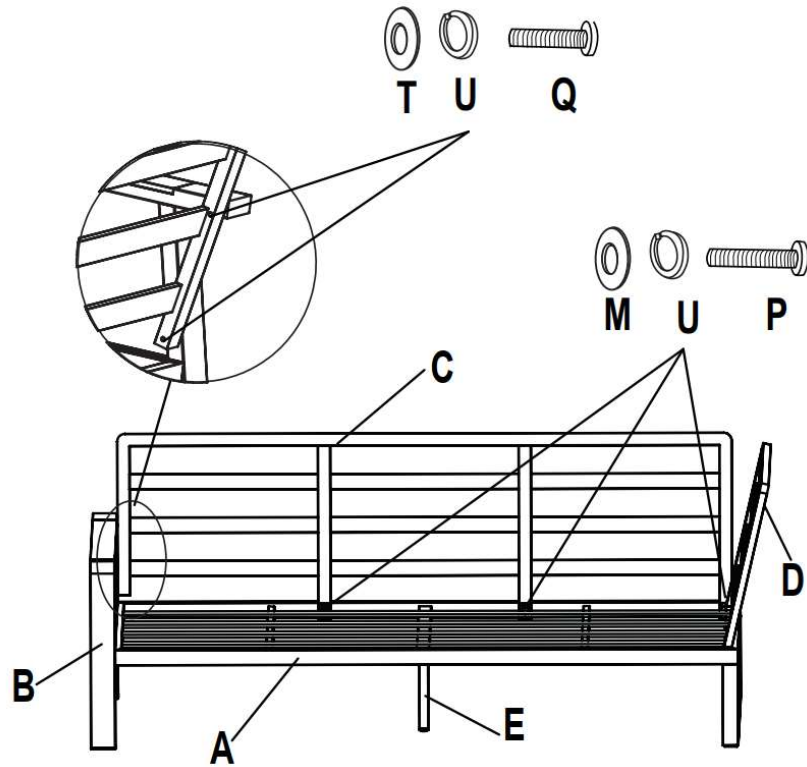



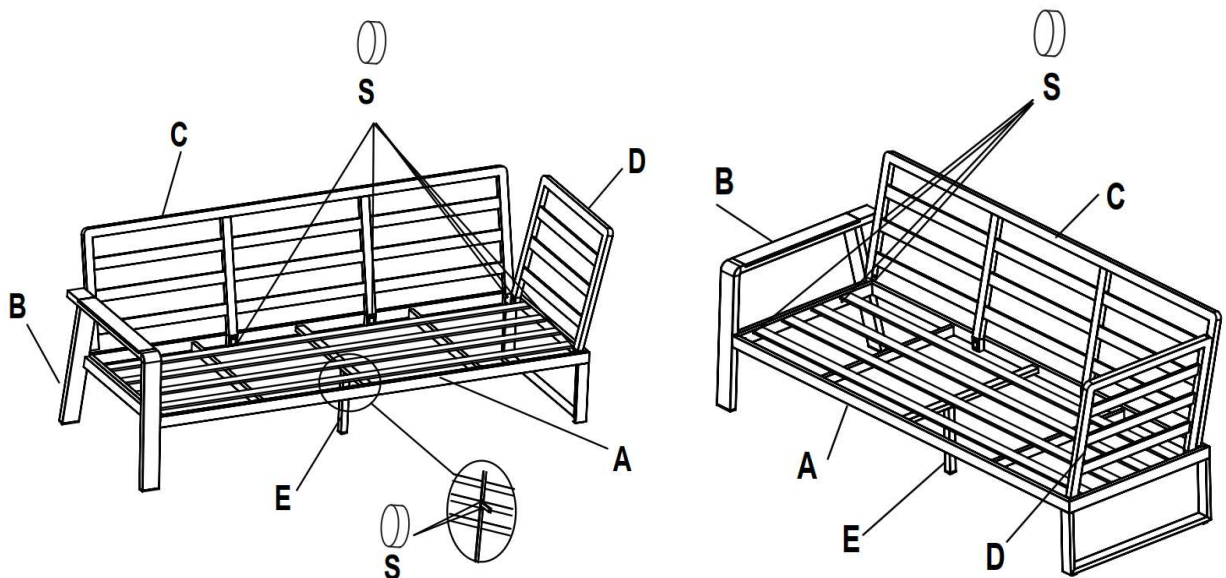





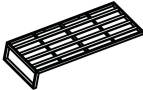



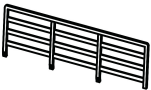
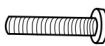

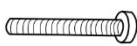

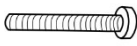
STEP 3: Attach Back board 1 (C) to Seat Frame1 (A) using the M6x45 Bolt (P), Lock washer (U) and Washer (M).
 Attach Back Rest 1 (C) to the Armrest 1 (B) using the M6x55 Bolt (Q), Lock washer (U) and Washer (T)

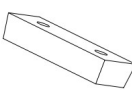

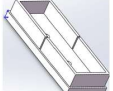
STEP 4: Tighten all the bolts on the right side sofa and cover with the Plastic bolt cap (S).
 Turn the sofa over.

PARTS LIST - LEFT HAND CORNER

Components					Fixings				
Parts List	Parts Picture	Description	Qty	Part No.	Parts List	Parts Picture	Description	Qty	Part No.
J		Seat Frame 2	1	69127062J 69127018J	M		Washer (M6*φ16)	12	1061162
K		Armrest 2	1	69127062K 69127018K	N		M6x20 Bolt	4	1091162
L		Back Rest 3	1	69127062L 69127018L	O		M6x35 Bolt	2	1111162
E		Centre Leg	1	69127062E 69127018E	P		M6x45 Bolt	6	1131162
F		Back Cushion	3	69127062F 69127018F	Q		M6x55 Bolt	2	1641162
H		Seat Cushion	3	69127062H 69127018H	R		M6 Allen Key	2	1010162
X		Footpad	2	2SIF002	S		Plastic Bolt Cap	14	1061163
Y		Footpad	2	2PIF001	T		Washer (M6*φ12)	2	1241162
Z		Adjustable Footpad	1	2PIF004	U		M6 Lock Washer	14	1051163
					W		Connector Bracket	1	1051164

STEP 5 - 9: FRAME ASSEMBLY- LEFT HAND CORNER

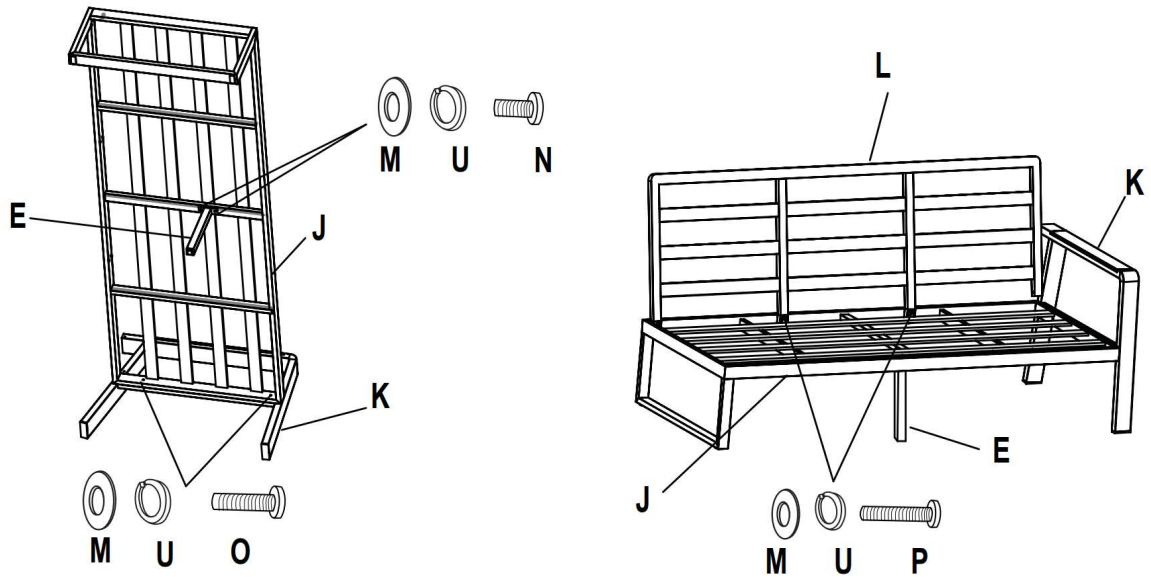

STEP 5: Attach Armrest 2 (K) to the Seat Frame 2 (J) using the M6x35 Bolt (O), Lock washer (U) and Washer (M). Attach Centre support leg (E) to the Seat Frame 2 (J) using the M6x20 Bolt (N), Lock washer (U) and Washer (M)

STEP 6: Attach Back Rest 3 (L) to the Seat Frame 2 (J) using the M6x45 Bolt (P), Lock washer (U) and Washer (M)

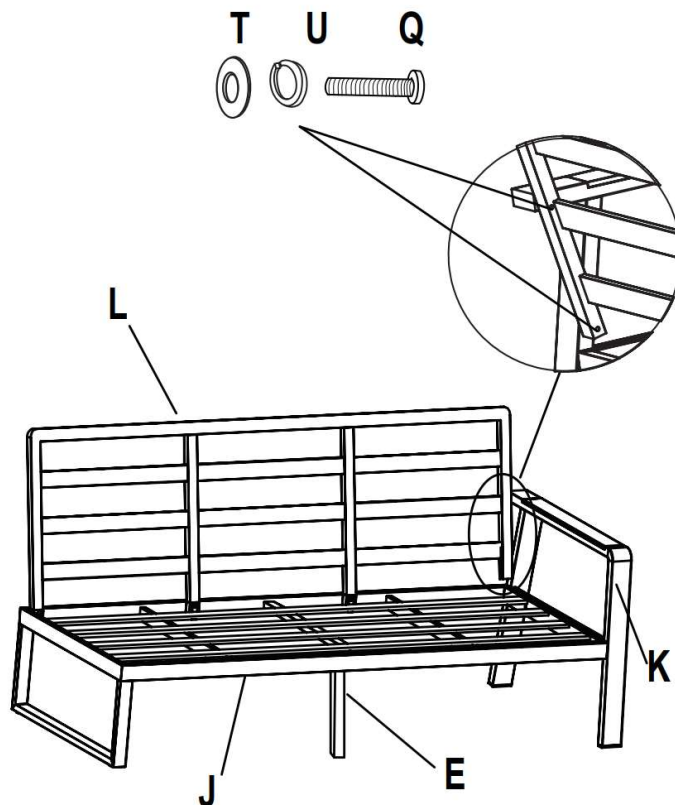

STEP 7: Attach Back Rest 3 (L) to the Armrest 2 (K) using the M6x55 Bolt (Q), Lock washer (U) and Washer (T)

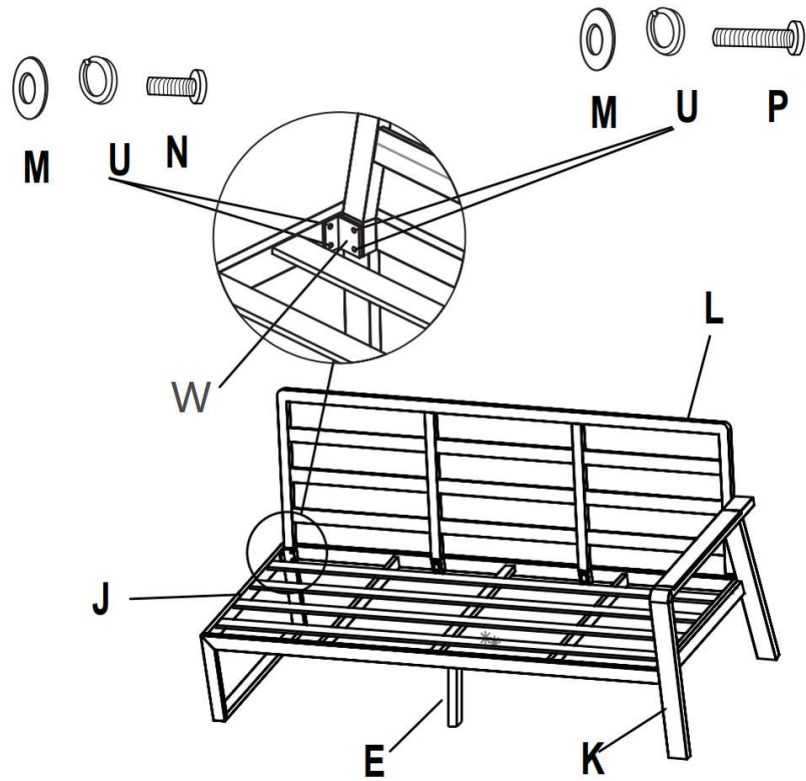

STEP 8: Attach the Connector Bracket (W) to Back Rest 3 (L) using the M6x45 Bolt (P), Lock washer(U) and Washer (M).
 Attach the Connector Bracket (W) to Seat board 2 (J) using the M6x20 Bolt (N) , Lock washer(U) and Washer (M)

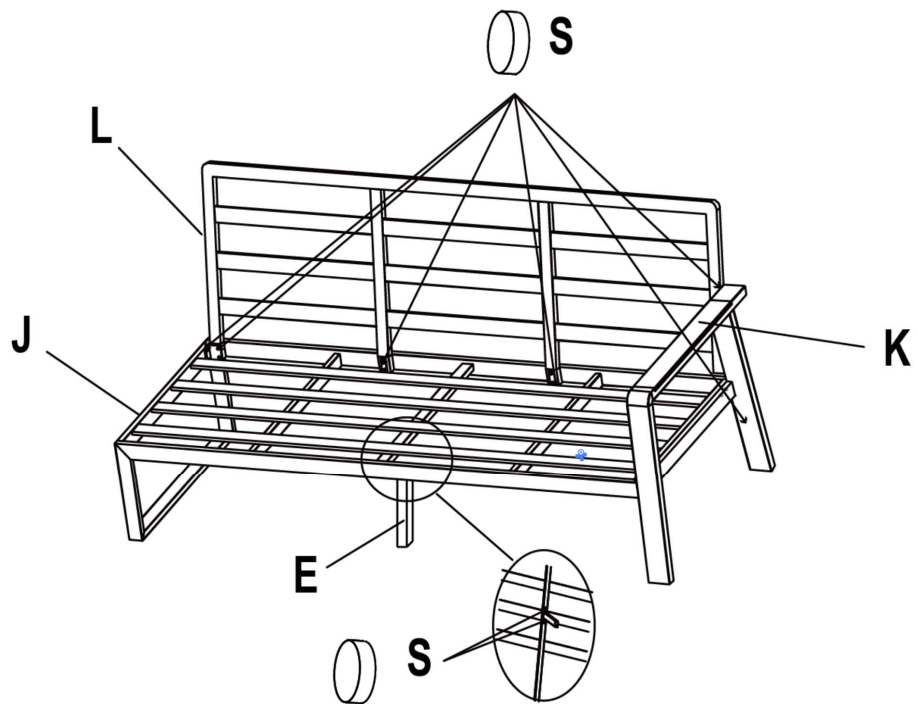

STEP 9: Tighten all the bolts on the left side sofa and cover with the Plastic bolt cap (S).
 Turn the sofa over.

STEP 10: TIGHTEN AND FINISHING

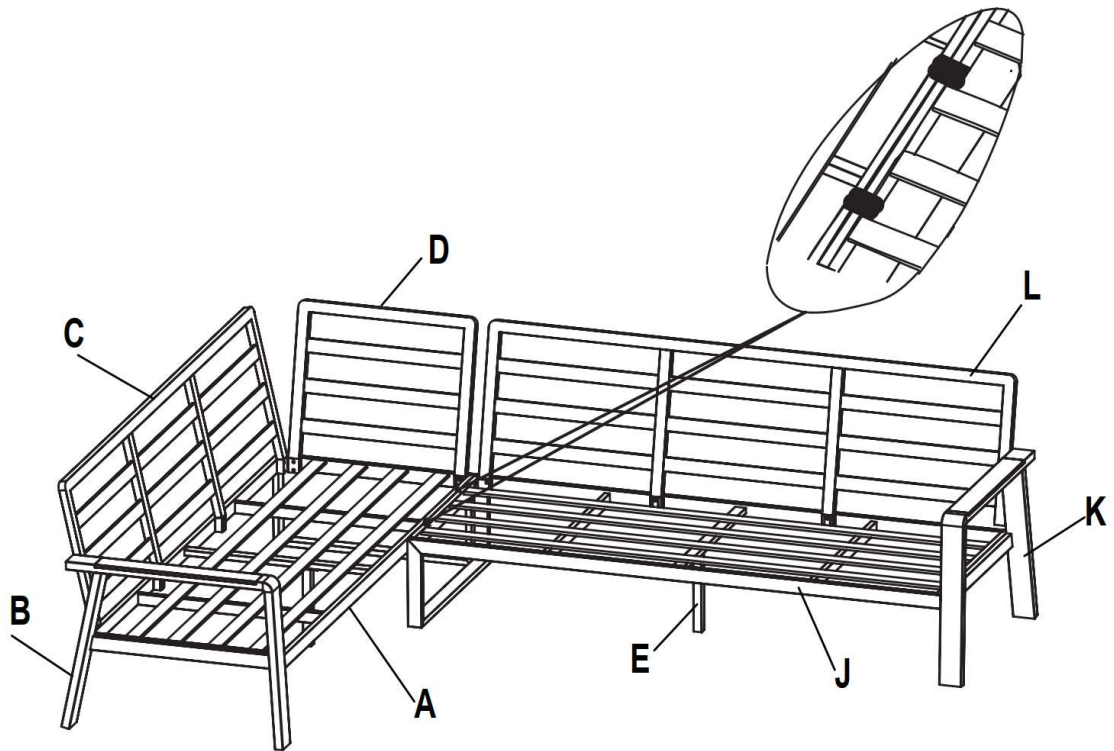

STEP 10: Fixed the right side and left side sofa using the Velcro (V). Place the Seat cushion (H), Corner seat cushion (I), Back cushion (F) and the Corner back cushion (G) onto the sofa

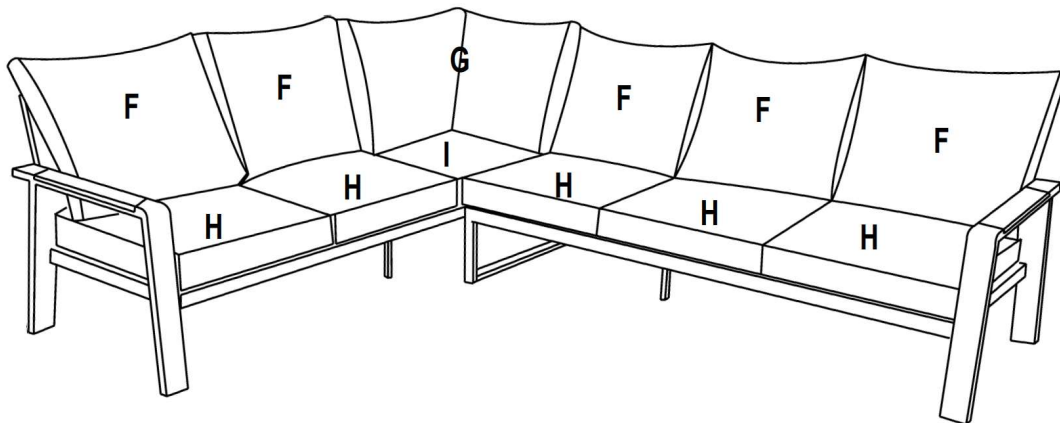



Assembly Instructions

Sonas 150x90cm Rectangular Adjustable Table

(Product Codes: 69125062 & 69126062)













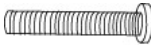

**PLEASE RETAIN THIS DOCUMENT ALONG WITH YOUR
PROOF OF PURCHASE FOR FUTURE REFERENCE**

Congratulations on your recent purchase of your beautiful Hartman furniture. We hope it brings you bountiful special moments with friends and family for many years to come. Please follow these simple steps to build your furniture. We also have a very useful video available online to assist with the assembly, please visit www.hartmanuk.com

TOP TIPS

- Please read these instructions carefully before assembly. For further assistance please view our assembly video online for an easy step by step demonstration.
- Aluminium is a soft metal and over tightening may strip the thread or break the part, please loosely assemble your furniture before tightening to secure.
- Please **do not** use power tools, please only use the tools provided in the bolt pack.
- Please allow **1 hour** for assembly
- This furniture can be assembled with **2** people; however, you may need someone to assist you when turning the furniture over into position.

PARTS LIST

Components					Fixings				
Parts List	Parts Picture	Description	Qty	Part No.	Parts List	Parts Picture	Description	Qty	Part No.
A		Table Top	1	69125062A	D		M6x25 Bolt	8	1017162
B		Leg Pillar	1	69126062B	E		M6x35 Bolt	2	1111162
C		Table Base	1	69125062C	F		M8x55 Bolt	8	2002166
					G		M6φ12 Washer	10	1241162
					H		M8φ20 Washer	8	1061191
					I		M6 Bolt Cap	10	1061163
					J		M8 Bolt Cap	8	1061164
					K		M6 Lock Washer	10	1051163
					L		M8 Lock Washer	8	1063162
					M		M6 Allen Key	1	1010162
					N		M8 Allen Key	1	1051162
					O		Adjustable Footpad	4	2SIF001

STEP 1 & 3: PILLAR ASSEMBLY

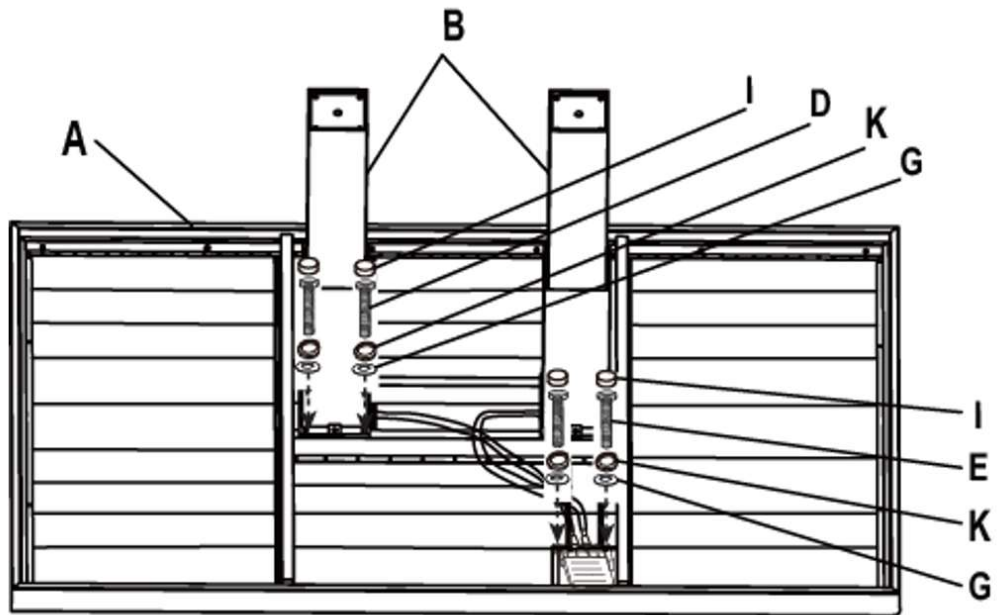

STEP 1: Attach leg pillar (B) to the table top (A), using the M6x25 bolt (D), lock washer (K) and washer (G).

STEP 2: Attach the handle to the Table top (A), using the M6x35 bolt (E), lock washer (K) and washer (G).
Tighten all the bolts and cover with the bolt cap (I)

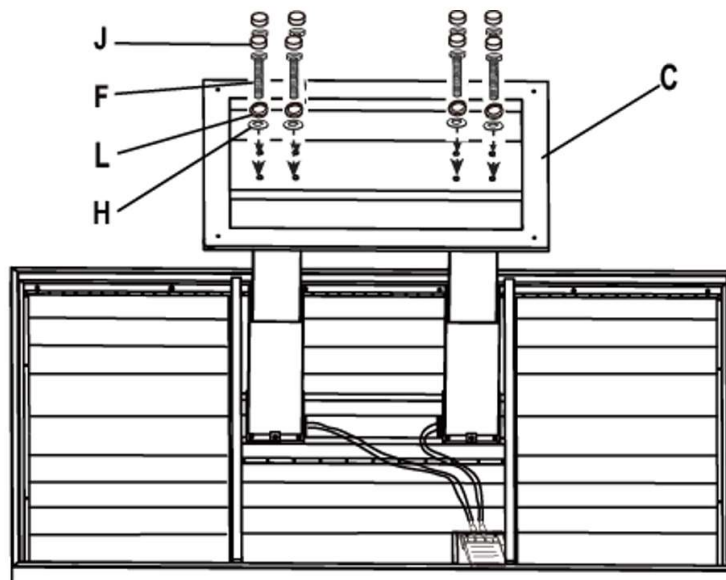

STEP 3: Attach base (C) to the pillar (B), using the M8x55 bolt (F), lock washer (L) and washer (H)

Tighten all the bolts and cover with the bolt cap (J)
Turn the table over, the table is now ready for use.

STEP 4: COMPLETE - RAISING AND LOWERING THE TABLE

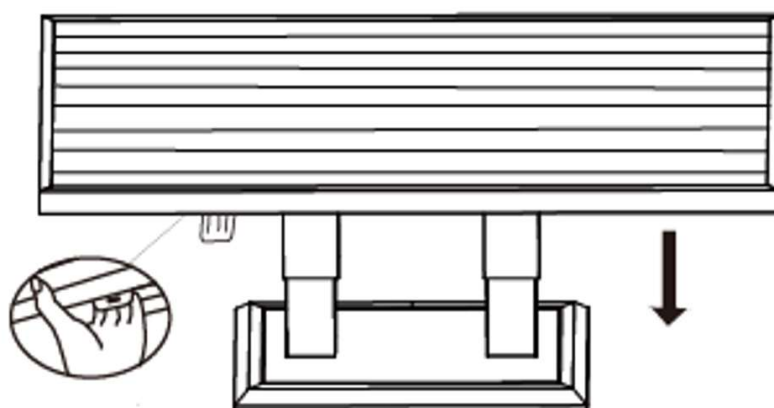
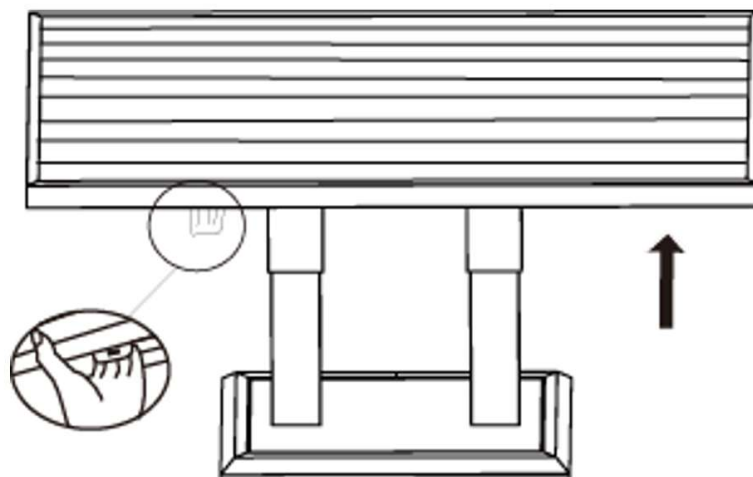
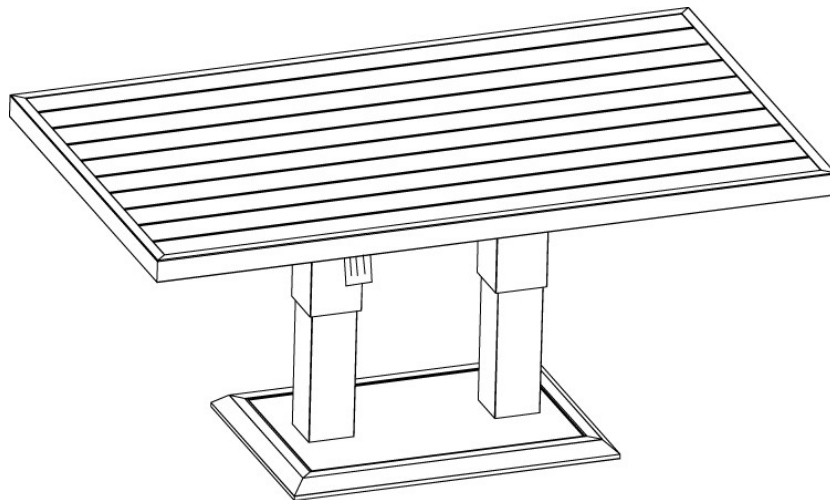

STEP 4: To raise the table gently squeeze the handle,
To lower the table, press gently on the centre of table top while squeezing
the handle.