



Assembly Instructions

Eton 4 Seat Round Dining Table

(Product Codes: 68803148)

**PLEASE RETAIN THIS DOCUMENT ALONG WITH YOUR
PROOF OF PURCHASE FOR FUTURE**













Congratulations on your recent purchase of your beautiful Hartman furniture. We hope it brings you countless special moments with friends and family for many years to come.

Please follow these simple steps to build your furniture. We also have a very useful video available online to assist with the assembly, please visit www.hartmanuk.com

TOP TIPS

- Please read these instructions carefully before assembly, for further assistance please view our assembly video online for an easy step by step demonstration.
- Aluminium is a soft metal and over tightening may strip the thread or break the part, please loosely assembly your furniture before tightening to secure.
- Please **do not** use power tools, please use the spanner provided in the bolt pack.
- Please allow 1 hour for assembly.
- This furniture can be assembled with **1** person; however, you may need someone to assist you when turning the furniture over into position.

PARTS LIST

Components					Fixings				
Parts List	Parts Picture	Description	Qty	Part no	Parts List	Parts Picture	Description	Qty	Part no
A		Table Top Frame	1	68803148A	E		M6*20 Bolts	4	2002169
B		Table Leg	2	68803148B	F		M6*40 Bolts	8	2002168
C		Table Side Panel	2	68803148C	G		Big Flat Washers	12	1061162
D		Millstone Ceramic Glass	1	68803148D	H		Small Lock Washers	12	1221162
					I		Nut Cap	12	2002170
					J		Spanner	1	1020162
					K		Parasol Bung, Reducer and Cap	3	2002183
					L		Plastic Washers	8	1008165

STEP 1 & 2: ASSEMBLY

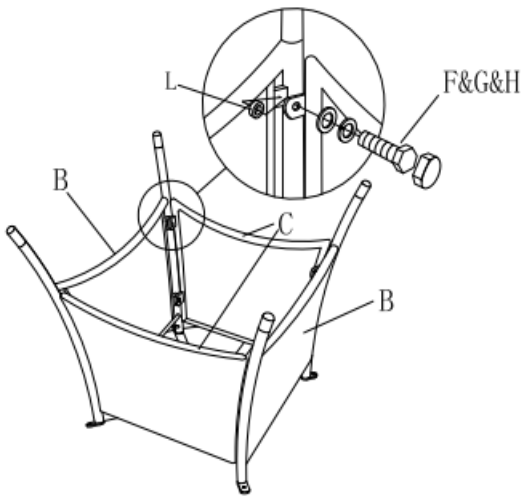

STEP 1: Loosely attach legs (B) to panels (C) with bolts (F), big flat washers (G), plastic washers (L) and lock washer (H) using spanner (J).

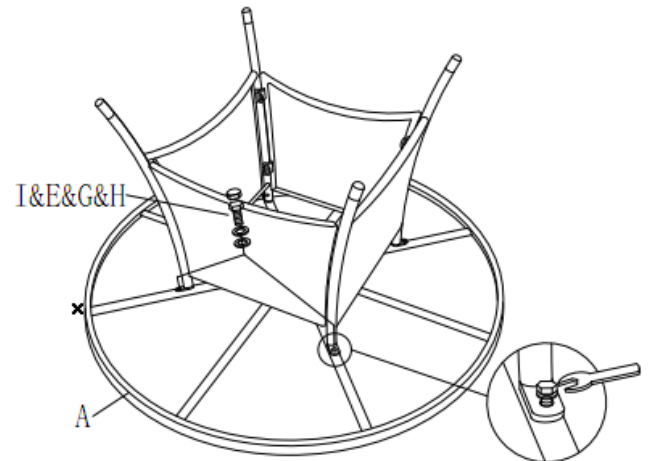

STEP 2: Loosely attach the pre-assembled leg section to the table top (A) with bolts (E), big flat washers (G) and small lock washer (H) using spanner (J). Tighten all bolts using the spanner (J). Place nut caps (I) on all visible bolts (E and F).

STEP 3: FLIP AND ADD GLASS



STEP 3: Turn your assembled table over and position where required. Carefully place glass top (D) onto the table top (A) within recessed weave and press gently onto the suckers. Then put parasol bungs & reducers (K) into the hole. You can now use the table.