



Assembly Instructions

Eton Lounger

(Product Codes: 68812148)

**PLEASE RETAIN THIS DOCUMENT ALONG WITH YOUR
PROOF OF PURCHASE FOR FUTURE**







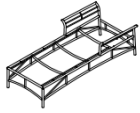

Congratulations on your recent purchase of your beautiful Hartman furniture. We hope it brings you countless special moments with friends and family for many years to come.

Please follow these simple steps to build your furniture. We also have a very useful video available online to assist with the assembly, please visit www.hartmanuk.com

TOP TIPS

- Please read these instructions carefully before assembly, for further assistance please view our assembly video online for an easy step by step demonstration.
- Aluminium is a soft metal and over tightening may strip the thread or break the part, please loosely assembly your furniture before tightening to secure.
- Please **do not** use power tools, please use the spanner provided in the bolt pack.
- Please allow 1 hour for assembly.
- This furniture can be assembled with **1** person; however, you may need someone to assist you when turning the furniture over into position.

PARTS LIST

Components					Fixings				
Parts List	Parts Picture	Description	Qty	Part no	Parts List	Parts Picture	Description	Qty	Part no
A		Lounger	1	68812148A	C		Plastic Washers	2	1040162
B		Backrest	1	68812148B	D		M8*55 Bolts	2	2002162
H		Cushion	1	5ENSC008OL	E		Big Flat Washers	2	1061162
					F		Nut Cap	2	2100038 2100039
					G		Spanner	1	1020162

STEP 1 & 2: ASSEMBLE LOUNGER

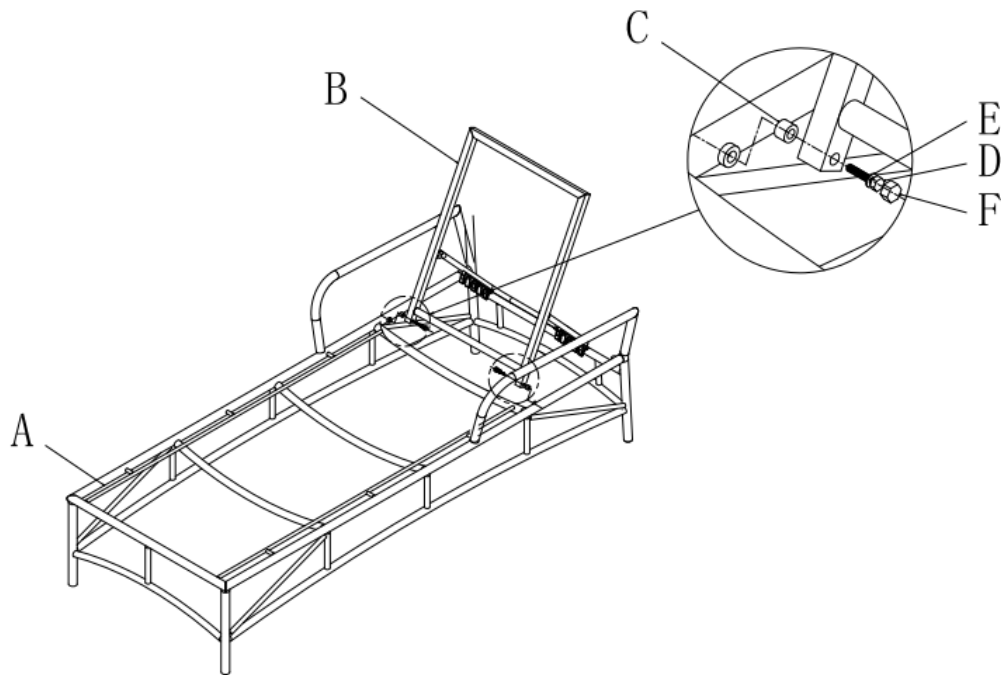

STEP 1: Attach backrest (B) to lounge (A) with bolts (D) and flat washers (E) and spacer (C) using spanner (G).

Tighten all bolts using spanner (G) one by one being careful not to over tighten any as this will cause the thread to become damaged.

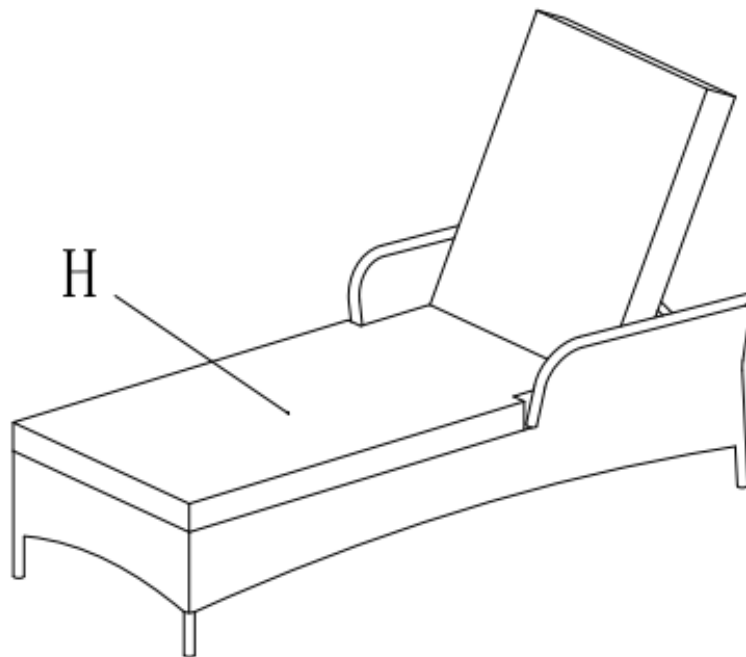

STEP 2: Place nut caps (F) on all visible bolts (D). Then put cushion (H) on the seat and fix well. You can now use the lounge.