

Assembly Instructions

KETTLER

Merano Sofa Set - Bench

007518-5000B2

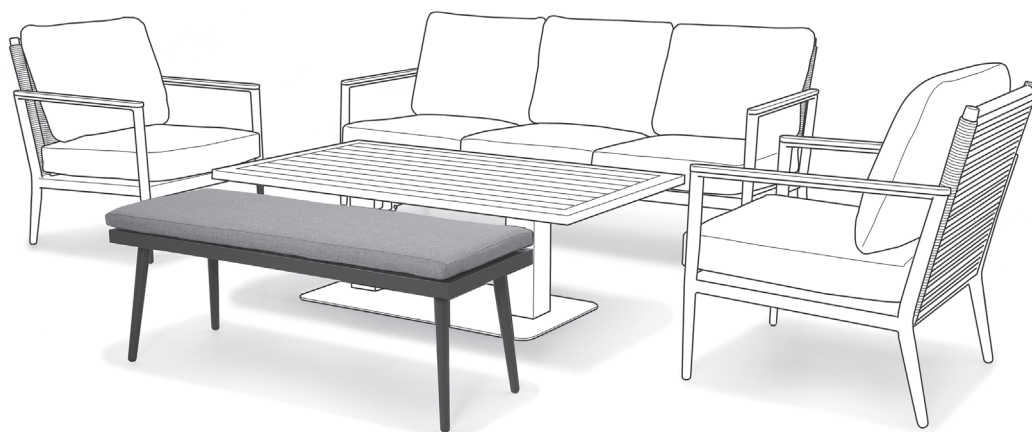

IMPORTANT

PLEASE KEEP THIS BOOKLET FOR FUTURE REFERENCE.
THIS IS IMPORTANT INFORMATION REGARDING THE
USE AND CARE OF YOUR GARDEN FURNITURE.



ASSEMBLY
TIME



PERSONS
REQUIRED



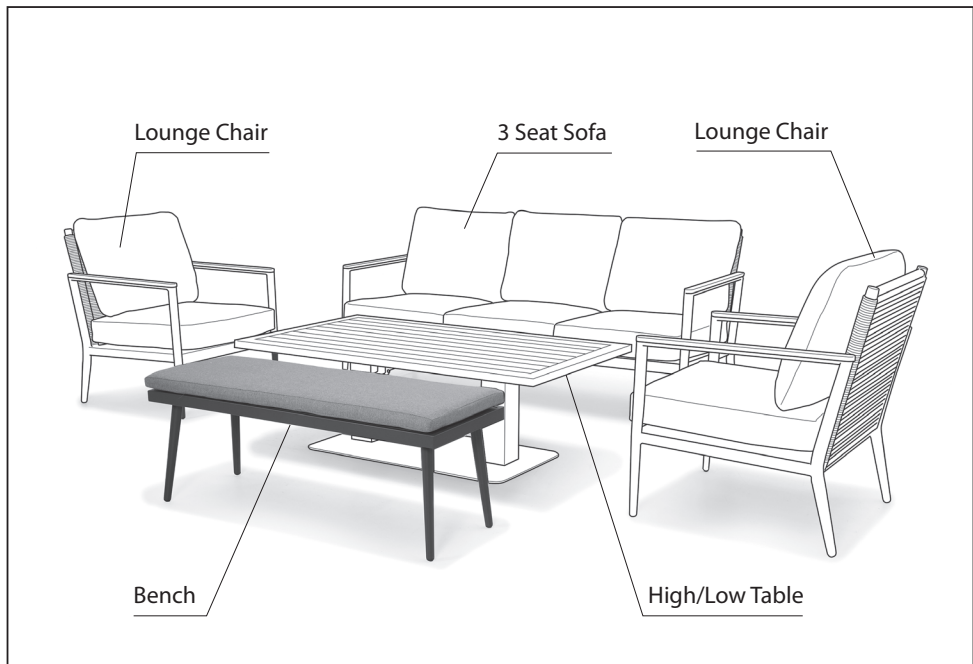

Assembly

Helpful advice before you begin:

1. We suggest you spend a short time reading through this leaflet and then follow the simple step by step instructions.
2. Do not discard any of the packaging until you have checked that you have all the parts and the pack of fittings.
3. Assemble this product on a soft surface.
4. To ensure an easier assembly, we strongly advise that all fittings are only finger tightened during initial assembly. Only upon completion of the assembly should all fixing points be fully tightened.
5. Keep fittings out of children's reach.
6. Do not use any other tools other than those recommended to build this product.
7. Please do not use substitute parts. Use only additional or replacement parts supplied by Kettler.
8. In the unlikely event that this product has missing or damaged parts, please visit our website www.kettler.co.uk

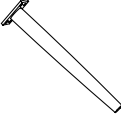

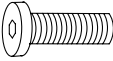
Parts List - Bench

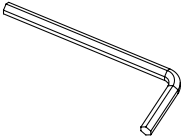
<p>(A) Seat Frame x1</p> 	<p>(B) Leg x4</p> 
<p>(C) Washer x16</p> 	<p>(D) Bolt M6 x 20 x16</p> 
<p>(E) Bolt Cover x16</p> 	<p>(F) Allen key x1</p> 

Assembly - Bench



Assemble on a soft surface.
Ensure this product is
protected during assembly
to avoid damage to the
surface

1.

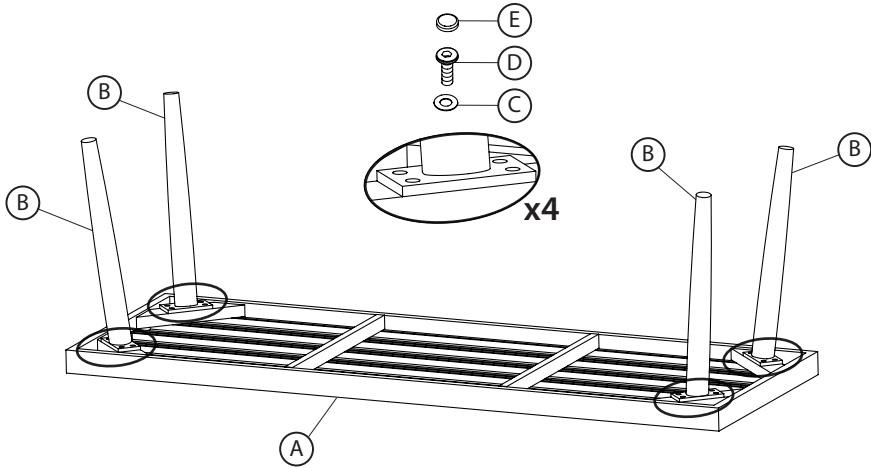

2.

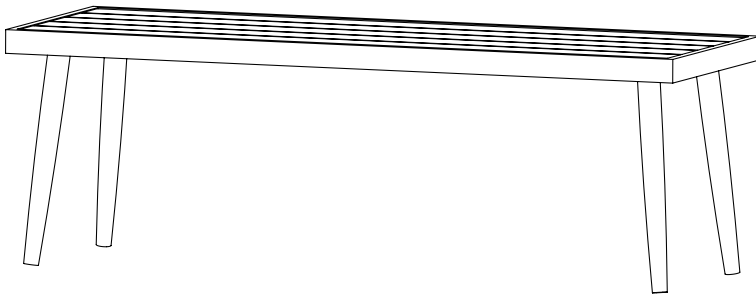

Finished

Maintenance and Care Instructions

This product may only be used for its intended purpose for residential premises. Any other uses may affect the warranty.

To maintain and lengthen the life of this product, we recommend the following regime:

- Kettler furniture is designed to be left outdoors all year round (excluding cushions).
- We recommend our weatherproof cushions are covered when not in use in order to use immediately. If the cushions get wet from a shower, they will take approx. 20 minutes – 2 hours to fully dry. We recommend storing in a dry ambient temperature during winter months.
- Kettler cushions are not suitable for dry cleaning and are not machine washable. Sponge clean only. We recommend the use of the Kettler fabric care kit to clean and protect your cushions. This is available to purchase from the Kettler website.
- The rope can be cleaned using the Kettler Fabric care kit. The aluminium frame can be cleaned with warm soapy water avoiding any harsh chemicals or the Kettler Multi-surface cleaner.
- Remove dust regularly with a clean soft brush and wipe down with a clean damp cloth.
- Tree sap and bird droppings should be cleaned off immediately with warm soapy water.
- The Kettler after-care range available is available to purchase from the Kettler website: www.kettler.co.uk
- Moving parts such as locking mechanisms, catches and joints need to be lubricated where necessary.
- Kettler furniture can be covered – we recommend that you use Kettler tailored covers (where available) or universal breathable covers.
- This product is 100% recyclable. At the end of the products life, please dispose of responsibly.
- Colours may vary slightly

Failure to comply with the outlined instructions will result in the warranty being invalidated.



For more information view our 'How-To' and maintenance videos:
kettler.co.uk/how-to-guides



Attention

Please be aware that painted/varnished surfaces can be damaged by sunscreens and oil based products. If the surface of your Kettler leisure furniture comes into contact with sunscreens, the surface is to be cleaned without delay as described above. Only in this way can lasting discolouration of the surface by the ingredients of the sunscreen be prevented.

For Your Safety

- This product may only be used for its intended purpose as furniture for residential properties.
- Check all components regularly for correct function, damage and loose connections especially at the start of the season and at 1-2 month intervals dependent on use.
- Damaged components may endanger your safety or shorten the life of the product. Replace all damaged parts immediately. Use only spare parts manufactured by Kettler. Should you wish to purchase spare parts, they can be ordered directly from: www.kettler.co.uk/shop
- Kettler will not be responsible for damaged caused by improper use.



Attention

- Whilst assembling this product keep out of the reach of children. (Choking hazard – contains small parts)
- Ensure that your working area is free of possible sources of danger, for example don't leave any tools lying around.
- Always dispose of packaging material in such a way that it may not cause any danger. There is always a risk of suffocation if children play with plastic bags!
- We reserve the right to make changes for technical reasons.

KETTLER

www.kettler.co.uk



PlanetMark



Warranty For Home Use

This product is covered by a 3 year warranty against manufacturing faults. This warranty applies to domestic use only. It does not cover commercial use, mis-use or accidental damage.

To validate your warranty, register at www.kettler.co.uk and quote the product code from the front of this booklet.