



EASYFOUNTAIN

Patio Pond Large

User Instructions - Please keep for future reference

45302



Technical Information

Pump power supply: 12V - 50Hz
Pump power rating: 17W
Pump ingress protection: IPX8
Dimensions: H737mm x W1005mm x D1009mm
Capacity: 167 Litres



These instructions form part of this appliance. Please be sure to read them before use and keep for future reference. This product is for domestic use only and should not be used commercially or for contract purposes.

Produced in PRC for The AMES Companies UK Ltd c/o Easy Fountain
The Old Airfield, Heck & Pollington Lane, Pollington, East Yorkshire, DN14 0BA
www.easyfountain.co.uk Tel: 01285 762060

Care and safe use guidelines

SAFETY INFORMATION

- The electrical transformer must always be connected through a portable residual-current device (RCD), or a built-in residual current circuit breaker (RCCB), having a rated residual operating current not exceeding 30mA. (This level of electrical protection was first incorporated into UK homes built after 2001.) If in doubt consult a certified electrician.
- Always isolate the electrical supply before cleaning the pump, or making any adjustments to its flow rate, or interconnected LEDs (where supplied).
- DO NOT route the electrical cable:
 - across any walkways;
 - across any grassed area that requires periodic cutting;
 - over any areas where it could cause a trip hazard;
 - on, or across, rough or sharp surfaces that could sever or cause abrasions to the cable;
 - bury the power cable underground as the cable is not armoured.
- Do not allow children to play with any part of this water feature – neither when it's in operation nor disconnected. This can pose risks of electric shock, drowning or poisoning.
- Never drink from the water reservoir nor its flow.
- The integral mains plug(s) of this product's sub-components must not be cut off nor modified for any purpose including: extending the cable length, wiring directly into an electrical spur, or modification of any type. Doing so may cause electrical safety or fire hazards and thereby invalidate the product warranty.
- Do not move the unit when in use. Wait until drained before moving and check that it has been unplugged from the electrical socket.
- If the pump's electrical cable becomes damaged, it must never be repaired but the complete pump appliance must be replaced with one of identical characteristics.

MAINTENANCE

- Always isolate the power before cleaning the fountain or pump.
- Replace water and clean components regularly to avoid premature parts failure – please refer to troubleshooting for details on this.
- Never operate the pump before being submersed in water as this will cause it to overheat and burn out.
- Top up the water on a regular basis. For effective pump usage the water level must always cover the pump by at least 5cm.
- Clean the main body only with a soft damp cloth, and mild detergent if necessary. Do not use any abrasive substance or cloth for cleaning as this could damage the surface of the appliance.
- Never submerge the electrical transformer in water nor site it in areas likely to flood or pool with water.
- Any transformers or extension leads should ideally be stored in a weatherproof box.
- If connecting your water feature to a mains outlet outside, it must be waterproof to IP56 rating.
- Do not run this product continuously.

WINTER CARE

- Remove all loose parts and electrical components.
- Empty water from the reservoir. For heavier fountains this can be done using a large sponge or a simple syphon pipe (available to purchase from aquatic supply stores).
- If water freezes within the fountain this can cause damage.
- If possible, bring your water feature indoors for example in a garage or shed during the winter or periods of extreme weather conditions – they should be stored in a clean, dry environment free from moisture and above 0°C.
- Protective covers are available to purchase to cover the entire water feature, however we cannot guarantee that this will protect it from winter damage.

DISPOSAL



This symbol means that used electrical and electronic equipment (WEEE) should not be mixed with general household waste. For proper treatment, recovery and recycling, please take this product(s) to designated collection points where it will be accepted free of charge. Please contact your local authority for further details of your nearest designated collection point.

Always isolate the electrical mains supply before touching or adjusting the pump. The pump flow can be adjusted with the regulator, this is found on the inlet of the pump. We recommend starting with the flow regulator fully open and then adjusting down if required.



Turn...
Clockwise for full flow
Anticlockwise for reduced flow

Troubleshooting

No Functionality:

- Ensure only the pump is in contact with water – transformers should not be submerged in water.
- Check the plug is fully inserted and the mains power is switched on.
- Check the mains power is working from the socket by plugging in another appliance and checking the functionality.
- Unplug the transformer from the mains power and remove from water. Unplug and clean all connections between the transformer and pump. It is advised the connection pins are cleaned with a scouring pad or wire wool to remove any oxidation and then reconnected until watertight.
- Check or replace the fuse in the transformer's mains plug with the same type / colour as the factory original fuse (red = 3A, black = 5A, brown = 13A).

Disconnect from mains power before attempting any of the below suggestions.

- Check the pipe is fully connected to the pump.
- Check there are no kinks in the connection between the pipe and pump.
- Check the pump is fully submerged in water and has at least 5cm of water above it.
- Check for a pump blockage – see pump cleaning below.

Poor water flow:

Disconnect from mains power before attempting any of the below suggestions.

- Check and increase the flow rate regulator on the pump. This can be either a mechanical rotary or slider control on the side of the pump (where fitted).
- Check there are no kinks in the connection between the pipe and pump.
- Ensure the pump is not positioned directly under a flow of water produced by the fountain, as this can cause surges in the water flow.
- Pump cleaning (basic) – remove pump from the water feature and disconnect water pipe. Immerse pump into a bucket of warm water then brush debris and algae away from the water screen/inlet slots.
- Pump cleaning (full) - remove pump from water, disconnect water pipe. Clean off algae from the water screen/ inlet slots then carefully but firmly pull apart the pump's inlet cover (a flat screwdriver or similar tool is useful to help unclip the cover) to reveal the magnetic impeller. Remove the impeller and clean thoroughly; reassemble the pump carefully.

Warranty conditions

COVERED UNDER WARRANTY

- If it has a crack or leak and has been reported within 30 days from purchase it is under warranty and should be returned complete with electrics and accessories in the original packaging.
- If the paint on the fountain has peeled during normal use and the winter care procedure has been followed, it is under warranty.
- If the fountain has been delivered damaged it must be reported straight away for this to be covered by the warranty.
- If the proof of purchase shows the product was bought within 1 year, a free of charge replacement part can be supplied.
- Please be aware Easy Fountain will ask for proof of purchase. You will be required to provide the following information: your contact details - name, address, contact number, email.

NOT COVERED UNDER WARRANTY

- Swelling or blistering on the casing of the pump.
- Pump smells of a burning residue.
- If the pump has a visible algae or limescale build up.
- Any damage to the plug or moulded inserts.
- Any damage caused by misuse or severe weather conditions.
- Cracks/leaks that have formed and not reported within 30 days from purchase.
- Paint and/or surface damage/discolouration due to limescale or frost damage.
- The transformer has a visible build-up of dirt and/or debris.

If any of the conditions above are found, it is likely that this is due to incorrect maintenance and the warranty will be void. Do not dispose of any components as further inspection by Easy Fountain may be requested.

Replacement parts are available from Easy Fountain (The AMES Companies UK Ltd), please contact our customer service team at ukproductsupport@ames.com or call 01285 762 060

Parts List

1. Water Outlet

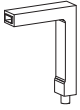

2. Basin

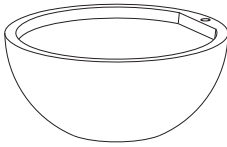

3. Hose & Flow Controller

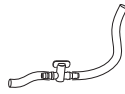

4. Pump

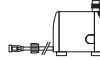

5. Transformer

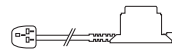

6. Levellers



7. Rubber Plug



Prior to assembly, read the instructions carefully. Check all parts against this parts list. Carry out assembly on a soft surface to avoid scratching the product. Please retain this information for future reference.

Assembly Instructions

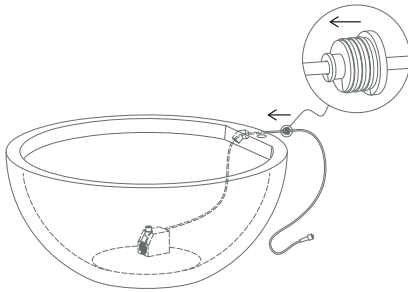

Step 1: Lay out all the components onto a clean, flat, smooth surface. Place the pump in the basin and thread the pump wire through the hole in the side of the basin. Now thread the wire through the rubber plug and then insert the rubber plug into the hole in side of basin.

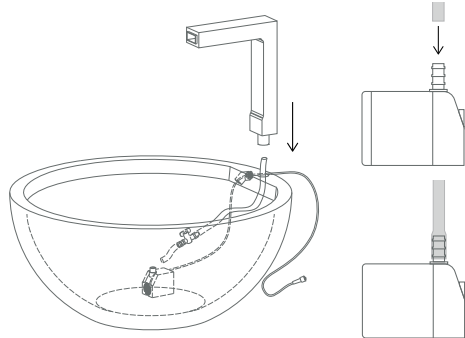

Step 2: Run the long hose through the hole on top of the basin. Connect the water hose to bottom of water spout. Push the water spout into the hole on top of the basin, making sure it is firmly in place and facing into the basin. Connect the tubing to the outlet of the pump and make sure that the pump flow regulator is open (turn clockwise for full flow). Now make sure that the flow controller on the hose pipe is open.

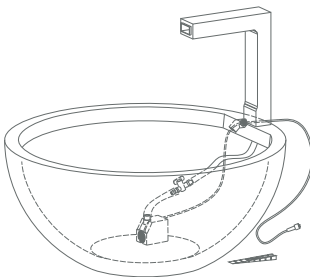

Step 3: Use the levellers to adjust the level of the fountain.

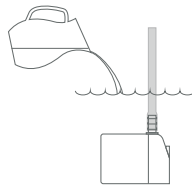

Step 4: Carefully fill the fountain with sufficient water ensuring the pump is fully submerged. Our recommendation is to ensure that the bowl is at least half full. Capacity is given as a guide only and is based on filling to 5mm below the underside of the rim.

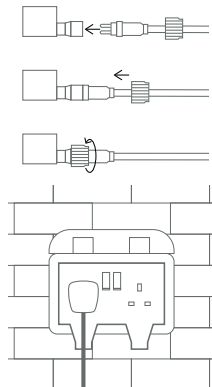

Step 5: Connect the pump connection to the transformer making sure the plastic screw cover is tight. Now connect the plug from the transformer to your mains outlet. Your water feature is now ready to use.

Note: It is recommended to clean the filter pad inside the pump every 3 months.