

PLEASE KEEP THIS BOOKLET
FOR FUTURE REFERENCE.
CONTAINS IMPORTANT
INFORMATION REGARDING
THE CARE AND USE OF YOUR
SUPREMO PRODUCT

Helpful advice before you begin: Please read carefully

- PLEASE READ THE INSTRUCTIONS THOROUGHLY BEFORE YOU COMMENCE ASSEMBLY - follow the simple step by step instructions in the correct sequence.
- Please check all components listed, are counted and corresponding to the required parts for building this product before assembling.
- This product requires 2 people to assemble this safely to prevent parts being damaged or injury to any person.
- NEVER USE A POWER TOOL TO ASSEMBLE.
- Do not discard any packaging until you have checked that you have all the parts and all the fittings.
- To ensure your product is not damaged during assembly, prepare a suitable area to build your furniture, either assemble on a clean soft surface or use the box that the products have been supplied in. This will prevent your product from damage and scratching during the building process.
- To begin the assembly follow the diagrams in order sequence as directed to ensure the correct method is followed for correct installation of each component.
- DO NOT tighten any bolts until all parts have been connected loosely with all bolts inserted into position, once all parts are connected then each bolt can be fully tightened using the tools provided.
- Do not use any other tools other than those recommended to build this product.
- Keep parts, fittings and packaging away from children.
- In the unlikely event this product has missing or damaged parts, please email our customer service department help@supremouk.com









For Your Safety

- This product may only be used for its intended purpose as furniture for residential properties.
- Check all components regularly for correct function, damaged and loose connections especially at the start of the season and at 1-2 months intervals dependent on use.
- Damaged components may endanger your safety or affect the quality of the product. Replace all damaged parts immediately. Use only spare parts provided by Supremo Ltd. Should you wish to discuss spare parts, please contact help@supremouk.com
- Supremo Ltd will not be responsible for damage caused by improper use.

ASSEMBLY INSTRUCTION

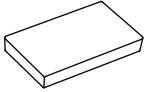
1 Seat Stool

PARTS LIST

A	SEAT		1	D	METAL WASHER		6	G	BASE CUSHION		1
B	LEG		2	E	PLASTIC BOLT CAP		6				
C	BOLT (M6*30MM)		6	F	ALLEN KEY		1				

Step 1

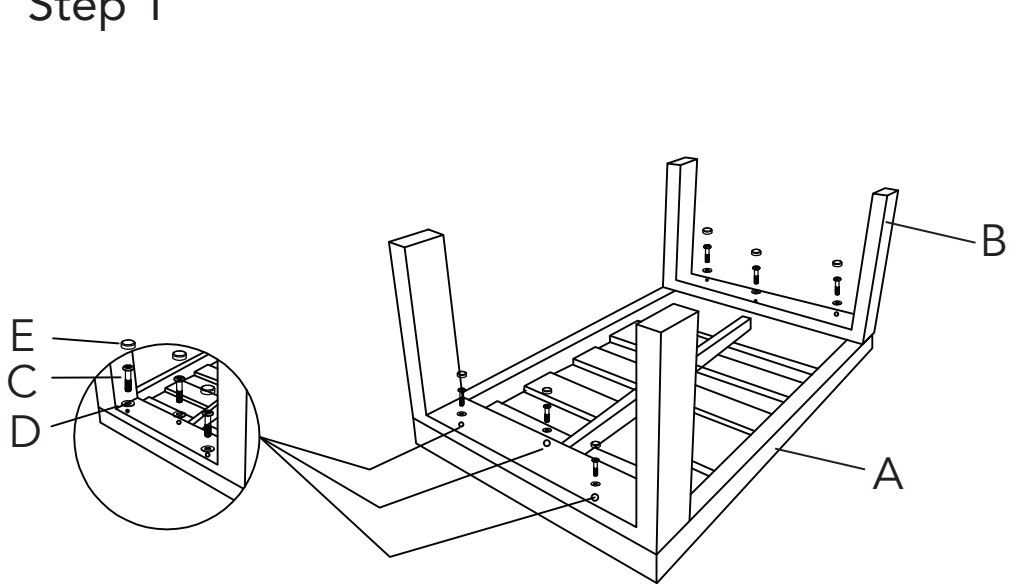

Step 2

